

**IEEE Std 315-1975 (Reaffirmed 1993)**

**ANSI Y32.2-1975 (Reaffirmed 1989)**

**CSA Z99-1975**

(Revision of IEEE Std 315-1971

ANSI Y32.1-1972

CSA Z99-1972)

**IEEE Standard**

**American National Standard**

**Canadian Standard**

# **Graphic Symbols for Electrical and Electronics Diagrams**

**(Including Reference Designation Letters)**

Sponsor

**IEEE Standards Coordinating Committee 11, Graphic Symbols**

Secretariat for American National Standards Committee Y32

**American Society of Mechanical Engineers  
Institute of Electrical and Electronics Engineers**

Approved September 4, 1975  
Reaffirmed October 20, 1988  
Reaffirmed December 2, 1993

**IEEE Standards Board**

Approved October 31, 1975  
Reaffirmed January 16, 1989

**American National Standards Institute**

Approved October 9, 1975  
**Canadian Standards Association**

Approved Adopted for Mandatory Use October 31, 1975  
**Department of Defense, United States of America**

IEEE Std 315-1975  
(ANSI Y32.2-1975)  
31 October, 1975

### Acceptance Notice

The following Industry Standardization Document was adopted on 31 October 1975 for mandatory use by the DoD. The indicated industry groups have furnished the clearances required by existing regulations. Copies of the documents are stocked by DoD Single Stock Point, Naval Publications and Forms Center, Philadelphia, PA, 19120, for issue to military activities only.

Title of Document: Graphic Symbols for Electrical and Electronics Diagrams (Including Reference Designation Class Designation Letters)

Document No. (a) IEEE Std 315-1975  
(b) ANSI Y32.2-1975

Date of Specific Issue Adopted: (a) 4 September, 1975  
(b) 31 October, 1975

Releasing Industry Group: (a) The Institute of Electrical and Electronics Engineers, Inc.  
(b) American National Standards Institute, Inc.

Supersedes: IEEE Std 315-1971  
(ANSI Y32.2-1970)

Custodians:  
Army - EL  
Navy - SH  
Air Force - 16

Military Coordinating Activity:  
Army - EL

Review Activities:  
Army - AV, MI, MU  
Navy AS, OS, SH, YD

User Activities:  
Army - ME  
Navy - EC, MC

Project Number: DRPR-0176

Certain provisions of this standard are subject of International Standardization Agreement, ABC NAVY STD-28A, Symbols and Abbreviations for Electrical and Electronics Drawings, to which the U.S. Army also subscribes. When reaffirmations, amendment, revision, or cancellation of this standard is proposed which will effect or violate the international agreement concerned, the Military Coordinating Activity will take appropriate reconciliation action through military international standardization channels including departmental standardization offices, if required.

NOTICE: When reaffirmation, amendment, revision, or cancellation of this standard is initially proposed, the cognizant secretariat of the industry standard shall inform the Military Coordinating Activity of the proposed change and request their participation.

Preface to CSA Standard Z99-1975 C11B

Graphic Symbols for Electrical and Electronics Diagrams

REXDALE, October 9, 1975

American National Standard Y32.2-1975 (IEEE Std 315-1975), with the modifications shown in Section 100, has been approved as CSA Standard Z99. This action was proposed by the Committee on Electrical Symbols, under the jurisdiction of the Sectional Committee on Abbreviations, Definitions and Symbols and was formerly approved by these Committees.

See Section 100, Canadian Standard Z99 modifications to American National Standard Y32.2-1975 on page 83.

NOTE: In order to keep abreast of progress in the industries concerned, CSA publications are subject to periodic review. Suggestions for improvement will be welcomed at all times. They will be recorded and in due course brought to the attention of the appropriate Committee for consideration.

Also, requests for interpretation will be accepted by the Committee. They should be worded in such a manner as to permit a simple "yes" or "no" answer based on the literal text of the requirement concerned.

All inquiries regarding this standard should be addressed to Canadian Standards Association, 178 Rexdale Boulevard, Rexdale, Ontario M9W 1R3, Canada.

## IEEE Standards Board

Approved September 4, 1975

**Joseph L. Koepfinger**, *Chair*

**Warren H. Cook**, *Vice Chair*

**Sava I. Sherr**, *Secretary*

Jean Jacques Archambault  
Robert D. Briskman  
Dale R. Cochran  
Louis Costrell  
Frank Davidoff  
Jay Forster  
Irvin N. Howell, Jr  
Stuart P. Jackson

Irving Kolodny  
William R. Kruesi  
Benjamin J. Leon  
Anthony C. Lordi  
Donald T. Michael  
Voss A. Moore  
William S. Morgan  
William J. Neiswender

Gustave Shapiro  
Ralph M. Showers  
Robert A. Soderman  
Leonard Thomas  
Charles L. Wagner  
William T. Wintringham

*Copyright © 1975 by the Institute of Electrical and Electronics Engineers, Inc. No part of this publication may be reproduced in any form, in an electronic retrieval system or otherwise, without the prior written permission of the publisher. However, individual symbols contained in this standard may be utilized without further permission of the IEEE. Any statement that the symbols used are in conformance with this standard shall be on the user's own responsibility.*

## Foreword

(This foreword is not a part of American National Standard Graphic Symbols for Electrical and Electronics Diagrams, Y32.2-1975 [IEEE Std 315-1975])

This American National Standard is a revision and expansion of American National Standard Graphic Symbols for Electrical and Electronics Diagrams, Y32.2-1970 (IEEE Std 315-1971).

A variety of specialized symbols originally used for aircraft applications have been added to make this standard more comprehensive. To improve coordination with IEC publication 117, IEC approved versions of capacitor, transformer, delay, associated conductors and specialized ground symbols have been added as alternates to those long used and standardized in the United States. A number of small changes have made the existing material more closely parallel to IEC Publication 117. Symbols have been added to cover additional devices in the photo sensitive semiconductor and specialized semiconductor fields, as well as for an electronic flash lamp. Known errors have been corrected and some items have been clarified.

The reference designation class letters were revised to include the added new device symbols and to clarify the DS and LS categories. “D” is now listed as an alternate to the common “CR” for the common semiconductor diode family of devices.

All of the symbols are designed so that their connection points fall on a modular grid. This should help those who use a grid basis for the preparation of diagrams. By proper enlargement of the symbols the usual coordinate-grid sizes can be matched. Most symbols appearing in this standard were reproduced from original drawings prepared for the Mergenthaler Diagrammer.

A substantial effort has been made to have this American National Standard compatible with approved International Electrotechnical Commission (IEC) Recommendations (IEC Publication 117, in various parts). Electrical diagrams are a factor in international trade; the use of *one* common symbol language ensures a clear presentation and economical diagram preparation for a variety of users. Members of the preparing committee have been active in transmitting USA viewpoints to the cognizant IEC Technical Committee.

Alternative symbols are shown only in those cases where agreement on a common symbol could not be attained at this time. It is hoped that the number of alternative symbols will be reduced in future editions.

The symbols in this standard represent the best consensus that can be attained at this time. Standardization, however, must be dynamic, not static, and any solution of a problem should be tested through use and revised if necessary. It is anticipated that the contents of this standard will be modified as future needs dictate; such modifications will be made available through the issuance of approved supplements. Suggestions for improvement are welcomed. They should be addressed to:

Secretary, IEEE Standards Board  
Institute of Electrical and Electronics Engineers, Inc.  
345 East 47 Street  
New York, N.Y. 10017

This standard has been prepared by the Institute of Electrical and Electronics Engineers (IEEE) Standards Coordinating Committee for Letter and Graphic Symbols (SCC 11), acting for the Y32.2 Task Group on Graphic Symbols for Electrical and Electronics Diagrams of the American National Standards Committee Y32, Graphic Symbols and Designations. There has been close cooperation between the industry and DOD representatives to provide one standard that can be universally used, rather than separate documents with their tendency to differ in various respects. While credit for this accomplishment is due all participants and the organizations they represent, particular mention is given to the U.S. Department of Defense, without whose strong support in reaching the objective—standard symbols acceptable to both industry and the military departments—the effort would not have succeeded.

This standard is complemented by a number of related standards listed in Section 23.

The American National Standards Committee on Graphic Symbols and Designations, Y32, had the following personnel at the time it approved this standard:

**Charles A. Fricke, Chair**  
**Conrad R. Muller, Vice Chair, Electrical and Electronics**  
**James L. Fisher, Jr., Vice Chair, Pictographic Symbols**  
**James R. Couper, Vice Chair, Chemical and Process**  
**George Platt, Vice Chair, Mechanical**  
**Alvin Lai, Secretary**

<i>Organization Represented</i>	<i>Name of Representative</i>
Acoustical Society of America .....	Laurence Batchelder Harry F. Olson
American Chemical Society.....	Robert F. Schuerer
American Gear Manufactures Association .....	Gerald L. Scott
American Institute of Chemical Engineers .....	James R. Couper
American Institute for Design and Drafting .....	Francis Saint
American Institute of Industrial Engineers .....	Irving Goldstein
American Institute of Mining, Metallurgical and Petroleum Engineers .....	(Vacant)
American Society of Agriculture Engineers .....	James A. Basselman
American Society of Civil Engineers.....	(Vacant)
American Society for Engineering Education .....	I. L. Hill R. T. Northup
American Society of Heating, Refrigerating and Air Conditioning Engineers .....	N. LaCourte C.W. MacPhee (Alt)
American Society of Mechanical Engineers .....	R. W. Cockrell A. R. Machell, Jr. O. J. Maha H. E. Walchli
American Society of Sanitary Engineering.....	James C. Church
American Welding Society .....	A. P. Arndt Frank Speight (Alt)
Association of American Railroads .....	M. F. McCorcle P. H. Foley
Association for Computing Machinery.....	Patrick G. Skelly Arthur C. Gannet (Alt)
Canadian Standards Association.....	A. Hendry
Illuminating Engineering Society .....	L. E. Barbrow John E. Kaufman (Alt)
Individual Member.....	Charles A. Fricke
Institute of Electrical and Electronics Engineers .....	G. A. Knapp Sidney V. Soanes Steven A. Wassermann
Instrument Society of America .....	George Platt Louis Costea (Alt)
Mechanical Contractors Association of America .....	J. R. Mance
National Association of Plumbing, Heating, Cooling Contractors .....	R. E. White
National Electrical Contractors Association .....	William H. Paules
National Electrical Manufacturers Association .....	Walter F. Huette F. V. Kupchak R. F. Franciose (Alt) Roland Russo (Alt) Mrs. R. L. Mancini (Alt)
National Fluid Power Association .....	James L. Fisher, Jr.

Society of Automotive Engineers .....	H. L. Dubocq
Technical Drawing Associates .....	W. D. Zbinder
Telephone Group.....	H. A. Spielman
	R. E. Thiemer ( <i>Alt</i> )
US Department of the Army, Ordnance.....	C. A. Nazian
US Department of Commerce, National Bureau of Standards .....	Gustave Shapiro
US Department of Commerce, Patent Office.....	D. M. Mills
US Department of the Interior .....	Ray Freeman
US Department of the Navy .....	( <i>Vacant</i> )
Western Union Telegraph Company .....	( <i>Vacant</i> )

The Task Group on Graphic Symbols, Y32.2, which revised and processed this standard, had the following personnel:

**C. A. Fricke\***, *Chair*  
**S. A. Wassermann**, *Secretary*

S. J. Balke	W. Grasson	C. A. Nazian
L. Batchelder	C. J. Hart	R. V. Rice
L. E. Barbrow	A. Hendry, <i>Canadian Liaison</i>	E. F. V. Robinson‡, <i>Canadian Liaison</i>
V. W. Bennett	G. A. Knapp	J. W. Siefert
H. L. Cook	R. Legg*	R. M. Stern*
D. Drusdow	L. A. Meadows‡	J. Zeno
S. K. Ghandi	C. R. Muller*	

The IEEE Standards Coordinating Committee on Letter and Graphic Symbols, SCC 11, had the following membership:

**C. A. Fricke**, *Chair*  
**C. R. Muller**, *Secretary*

R. B. Augus, Jr	G. A. Knapp	R. M. Stern
F. K. Becker	L. A. Meadows‡	L. H. Warren
J. C. Brown	R. V. Rice	S. A. Wassermann
J. M. Carroll	G. Shapiro	J. C. White
H. L. Cook	J. W. Siefert	
E. T. B. Gross	S. V. Soanes	

The IEEE Subcommittee on Graphic Symbols, SCC 11.1, and the IEC Experts Subcommittee, SCC 11.6, had the following membership:

**C. A. Fricke**, *Chair SCC 11.1*  
**C. A. Fricke**, *Chair pro tem, SCC 11.6*

V. W. Bennett	R. Legg	J. W. Siefert ( <i>SCC 11.1</i> )
I. M. Berger ( <i>SCC 11.1</i> )	J. Lusti ( <i>SCC 11.6</i> )	H. Seaman
T. L. Bisbee	L. A. Meadows‡	P. G. Skelly ( <i>SCC 11.6</i> )
V. Condello	C. R. Muller	S. V. Soanes ( <i>SCC 11.1</i> )
H. L. Cook	G. Panula ( <i>SCC 11.6</i> )	R. M. Stern
D. Drusdow	R. V. Rice ( <i>SCC 11.1</i> )	S. A. Wasserman
A. C. Gannett	A. I. Rubin ( <i>SCC 11.1</i> )	R. Rondinelli ( <i>Alt</i> )
G. A. Knapp	F. A. Saint	W. W. Varnedoe ( <i>SCC 11.6</i> )
E. J. Lombardi ( <i>SCC 11.6</i> )	G. Shapiro	J. Zeno ( <i>SCC 11.1</i> )

\* Member of Y32.2 Editorial Committee.

‡ Retired.

CLAUSE	PAGE
Introduction .....	1
A1 Scope .....	1
A2 Arrangement.....	2
A3 Application.....	2
A4 Drafting Practices Applicable to Graphic Symbols .....	3
Section 1 Qualifying Symbols .....	5
1.1 Adjustability	
Variability .....	5
1.2 Special-Property Indicators.....	7
1.3 Radiation Indicators (electromagnetic and particulate) .....	8
1.4 Physical State Recognition Symbols.....	9
1.5 Test-Point Recognition Symbol.....	10
1.6 Polarity Markings.....	10
1.7 Direction of Flow of Power, Signal, or Information.....	12
1.8 Kind of Current (General).....	13
1.9 Connection Symbol.....	14
1.10 Envelope	
Enclosure.....	17
1.11 Shield	
Shielding .....	18
1.12 Special Connector or Cable Indicator.....	19
1.13 Electret (shown with electrodes).....	19
Section 2 Graphic Symbols for Fundamental Items (not included in other sections).....	19
2.1 Resistor.....	19
2.2 Capacitor .....	24
2.3 Antenna .....	28
2.4 Attenuator.....	32
2.5 Battery .....	33
2.6 Delay Function	
Delay Line	
Slow-Wave Structure .....	34
2.7 Oscillator	
Generalized Alternating-Current Source .....	35
2.8 Permanent Magnet .....	35
2.9 Pickup	
Head .....	35
2.10 Piezoelectric Crystal Unit (including Crystal Unit, Quartz ).....	36
2.11 Transducer	
Accelerometer	
Motional Pickup Transducer .....	36
2.12 Squib, Electric .....	37
2.13 Thermocouple (dissimilar-metals device).....	37
2.14 Thermal Element	
Thermomechanical Transducer .....	38
2.15 Spark Gap	
Igniter Gap .....	38

CLAUSE	PAGE
2.16 Continuous Loop Fire Detector (temperature sensor).....	38
2.17 Ignitor Plug .....	38
Section 3 Graphic Symbols for Transmission Path .....	39
3.1 Transmission Path	
Conductor	
Cable	
Wiring.....	39
3.2 Distribution Lines	
Transmission Lines .....	45
3.3 Alternative or Conditional Wiring .....	47
3.4 Associated or Future .....	47
3.5 Intentional Isolation of Direct-Current Path in Coaxial or Waveguide Applications.....	48
3.6 Waveguide .....	48
3.7 Strip-Type Transmission Line .....	49
3.8 Termination.....	49
3.9 Circuit Return.....	50
3.10 Pressure Tight Bulkhead Cable Gland	
Cable Sealing End.....	51
Section 4 Graphic Symbols for Contacts, Switches, Contactors, and Relays.....	52
4.1 Switching Function .....	52
4.2 Electrical Contact .....	52
4.3 Basic Contact Assemblies.....	54
4.4 Magnetic Blowout Coil .....	57
4.5 Operating Coil	
Relay Coil.....	57
4.6 Switch.....	58
4.7 Pushbutton, Momentary or Spring-Return.....	59
4.8 Two-circuit, Maintained or Not Spring-Return .....	60
4.9 Nonlocking Switch, Momentary or Spring-Return.....	60
4.10 Locking Switch .....	61
4.11 Combination Locking and Nonlocking Switch.....	62
4.12 Key-Type Switch	
Lever Switch .....	62
4.13 Selector or Multiposition Switch .....	63
4.14 Limit Switch	
Sensitive Switch .....	66
4.15 Safety Interlock.....	67
4.16 Switches with Time-Delay Feature.....	68
4.17 Flow-Actuated Switch.....	69
4.18 Liquid-Level-Actuated Switch.....	69
4.19 Pressure- or Vacuum-Actuated Switch .....	69
4.20 Temperature-Actuated Switch .....	70
4.21 Thermostat .....	70
4.22 Flasher	
Self-Interrupting Switch .....	71
4.23 Foot-Operated Switch	
Foot Switch .....	72



CLAUSE	PAGE
4.24 Switch Operated by Shaft Rotation and Responsive to Speed or Direction .....	72
4.25 Switches with Specific Features .....	73
4.26 Telegraph Key .....	73
4.27 Governor (Contact-making)	
Speed Regulator.....	74
4.28 Vibrator, Interrupter .....	74
4.29 Contactor.....	74
4.30 Relay .....	76
4.31 Inertia Switch (operated by sudden deceleration).....	78
4.32 Mercury Switch.....	78
4.33 Aneroid Capsule (air pressure) Operated Switch.....	79
 Section 5 Graphic Symbols for Terminals and Connectors.....	 79
5.1 Terminals .....	79
5.2 Cable Termination.....	81
5.3 Connector	
Disconnecting Device	
Jack	
Plug .....	81
5.4 Connectors of the Type Commonly Used for Power-Supply Purposes .....	84
5.5 Test Block .....	86
5.6 Coaxial Connector	
Coaxial Junction.....	86
5.7 Waveguide Flanges	
Waveguide Junction.....	87
 Section 6 Graphic Symbols for Transformers, Inductors, and Windings .....	 88
6.1 Core.....	88
6.2 Inductor	
Winding (machine or transformer)	
Reactor Radio-Frequency Coil	
Telephone Retardation Coil .....	89
6.3 Transducer	
Saturable-Core Inductor	
Saturable-Core Reactor.....	90
6.4 Transformer	
Telephone Induction Coil	
Telephone Repeating Coil .....	92
6.5 Linear Coupler .....	100
 Section 7 Graphic Symbols for Electron Tubes and Related Devices .....	 100
7.1 Electron Tube .....	100
7.2 General Notes.....	104
7.3 Typical Applications.....	105
7.4 Solion	
Ion-Diffusion Device .....	109
7.5 Coulomb Accumulator	
Electrochemical Step-Function Device .....	110

CLAUSE	PAGE
7.6 Conductivity Cell .....	110
7.7 Nuclear-Radiation Detector (gas-filled)	
Ionization Chamber	
Proportional Counter Tube	
Geiger-Müller Counter Tube .....	110
Section 8 Graphic Symbols for Semiconductor Devices .....	111
8.1 Semiconductor Device	
Transistor	
Diode .....	111
8.2 Element Symbols .....	111
8.3 Special-Property Indicators.....	116
8.4 Rules for Drawing Style 1 Symbols.....	117
8.5 Typical Applications, Two-Terminal Devices.....	118
8.6 Typical Applications, Three- (or more) Terminal Devices.....	123
8.7 Photosensitive Cell.....	129
8.8 Semiconductor Thermocouple .....	130
8.9 Hall Element	
Hall Generator .....	130
8.10 Photon-Coupled Isolator .....	130
8.11 Solid-State Thyatron (replacement type).....	131
Section 9 Graphic Symbols for Circuit Protectors.....	132
9.1 Fuse (one-time thermal current-overload device).....	132
9.2 Current Limiter (for power cable).....	133
9.3 Lightning Arrester	
Arrester (electric surge, etc)	
Gap .....	134
9.4 Circuit Breaker .....	135
9.5 Protective Relay .....	136
Section 10 Graphic Symbols for Acoustic Devices .....	140
10.1 Audible-Signaling Device.....	140
10.2 Microphone	
Telephone Transmitter.....	142
10.3 Handset	
Operator's Set.....	142
10.4 Telephone Receiver	
Earphone	
Hearing-Aid Receiver.....	143
Section 11 Graphic Symbols for Lamps and Visual-Signaling Devices .....	144
11.1 Lamp .....	144
11.2 Visual-Signaling Device .....	146
Section 12 Graphic Symbols for Readout Devices .....	148
12.1 Meter .....	148

CLAUSE	PAGE
12.2 Electromagnetically Operated Counter Message Register.....	149
Section 13 Graphic Symbols for Rotating Machinery .....	150
13.1 Rotating Machine.....	150
13.2 Field, Generator or Motor .....	151
13.3 Winding Connection Symbols .....	152
13.4 Applications: Direct-Current Machines .....	153
13.5 Applications: Alternating-Current Machines.....	158
13.6 Applications: Alternating-Current Machines with Direct-Current Field Excitation .....	161
13.7 Applications: Alternating- and Direct-Current Composite.....	162
13.8 Synchro .....	163
Section 14 Graphic Symbols for Mechanical Functions.....	164
14.1 Mechanical Connection	
Mechanical Interlock.....	164
14.2 Mechanical Motion .....	165
14.3 Clutch	
Brake .....	166
14.4 Manual Control .....	167
Section 15 Graphic Symbols Commonly Used in Connection with VHF, UHF, SHF Circuits.....	168
15.1 Discontinuity (Introducing intentional wave reflection).....	168
15.2 Coupling.....	170
15.3 Directional Coupler .....	172
15.4 Hybrid	
Directionally Selective Transmission Devices.....	173
15.5 Mode Transducer .....	174
15.6 Mode Suppressor.....	175
15.7 Rotary Joint (radio-frequency rotary coupler) .....	175
15.8 Nonreciprocal Devices.....	176
15.9 Resonator	
Tuned Cavity .....	177
15.10 Resonator (cavity-type) Tube.....	178
15.11 Magnetron .....	178
15.12 Velocity-Modulation (velocity-variation) Tube.....	179
15.13 Transmit-Receive (TR) Tube .....	179
15.14 Traveling-Wave-Tube .....	180
15.15 Balun .....	182
15.16 Filter .....	182
15.17 Phase Shifter (matched) .....	182
15.18 Ferrite Bead Ring.....	183
15.19 Line Stretcher (with female connectors shown) .....	183

CLAUSE	PAGE
Section 16 Graphic Symbols for Composite Assemblies .....	184
16.1 Circuit Assembly	
Circuit Subassembly	
Circuit Element .....	184
16.2 Amplifier .....	185
16.3 Rectifier.....	187
16.4 Repeater (includes Telephone Repeater) .....	187
16.5 Network	
Artificial Line (other than delay line).....	188
16.6 Phase Shifter	
Phase-Changing Network.....	188
16.7 Chopper .....	189
16.8 Diode-Type Ring Demodulator	
Diode-Type Ring Modulator .....	190
16.9 Gyro	
Gyroscope	
Gyrocompass .....	190
16.10 Position Indicator .....	190
16.11 Position Transmitter.....	191
16.12 Fire Extinguisher Actuator Heads.....	191
Section 17 Graphic Symbols for Analog and Digital Logic Functions .....	192
17.1 Operational Amplifier.....	192
17.2 Summing Amplifier .....	192
17.3 Integrator (Amplifier) .....	192
17.4 Electronic Multiplier .....	193
17.5 Electronic Divider.....	193
17.6 Electronic Function Generator.....	193
17.7 Generalized Integrator.....	193
17.8 Positional Servomechanism .....	193
17.9 Function Potentiometer .....	193
Section 18 Graphic Symbols for Digital Logic Functions.....	194
18.1 Digital Logic Functions .....	194
Section 19 Graphic Symbols for Special-Purpose Maintenance Diagrams .....	194
19.0 Introduction.....	194
19.1 Data-Flow Code Signals .....	195
19.2 Functional Circuits.....	197
Section 20 Graphic Symbols Commonly Used on System Diagrams, Maps, and Charts .....	198
20.1 Radio Station.....	198
20.2 Space Station.....	200
20.3 Exchange Equipment .....	201
20.4 Telegraph Repeater .....	201
20.5 Telegraph Equipment.....	203
20.6 Telephone Set.....	206

CLAUSE	PAGE
Section 21 Graphic Symbols Commonly Used on System Diagrams, Maps, and Charts .....	208
21.1 Generating Station.....	208
21.2 Hydroelectric Generating Station.....	208
21.3 Thermoelectric Generating Station .....	209
21.4 Prime Mover (qualifying symbols) .....	210
21.5 Substation.....	210
Section 22 Class Designation Letters .....	211
22.1 Class Designation Letter .....	211
22.2 Special Considerations for Class Designation Letter Assignment.....	211
22.3 Item Names .....	212
22.4 Class Designation Letters: Alphabetical List.....	212
22.5 Item Names: Alphabetical List .....	220
22.6 Item Designations, IEC 113-2.....	220
Section 23 Referenced Standards and Canadian Standard Z99 Modifications.....	220
23.1 Referenced Standards .....	220
100 Canadian Standard Z99 Modifications to American National Standard Y32.2-1975 (IEEE Std 315-1975).....	221
Annex A (Informative) Cross Reference List of Changed Item Numbers .....	222
Annex B (Informative) Reference Data International Electrotechnical Commission (IEC) Publication 117: Recommended Graphical Symbols.....	223
Annex C (Informative) Revised or Deleted Symbols .....	225
Annex D (Informative) Revised or Deleted Symbols .....	226
Annex E (Informative) Revised or Deleted Symbols .....	236
Annex F (Informative) Cross-Reference List of Class Designation Letters .....	241

# Quick Reference to Symbols

## 1. Qualifying Symbols

### 1.1 Adjustability Variability



### 1.2 Special-Property Indicators



### 1.3 Radiation Indicators

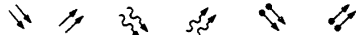

### 1.4 Physical State Recognition Symbols



### 1.5 Test-Point Recognition Symbol



### 1.6 Polarity Markings

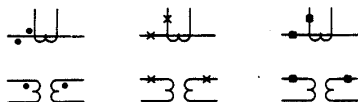

### 1.7 Direction of Flow of Power, Signal, or Information

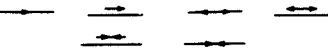

### 1.8 Kind of Current



### 1.9 Connection Symbols

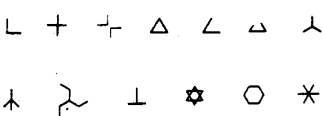

### 1.10 Envelope Enclosure

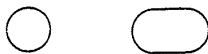

### 1.11 Shield Shielding



### 1.12 Special Connector or Cable Indicator



### 1.13 Electret



## 2. Fundamental Items

### 2.1 Resistor



### 2.2 Capacitor

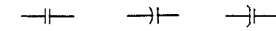

### 2.3 Antenna

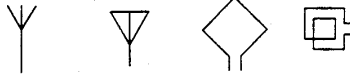

### 2.4 Attenuator

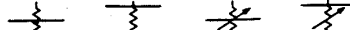

### 2.5 Battery



### 2.6 Delay Function Delay Line Slow-Wave Structure



### 2.7 Oscillator Generalized Alternating-Current Source



### 2.8 Permanent Magnet



### 2.9 Pickup Head

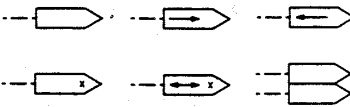

### 2.10 Piezoelectric Crystal Unit



### 2.11 Primary Detector Measuring Transducer



### 2.12 Squib, Electrical



### 2.13 Thermocouple



### 2.14 Thermal Element Thermomechanical Transducer

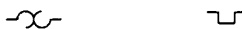

### 2.15 Spark gap Igniter gap



### 2.16 Continuous Loop Fire Detector (temperature sensor)



### 2.17 Ignitor Plug



## 3. Transmission Path

### 3.1 Transmission Path Conductor Cable Wiring

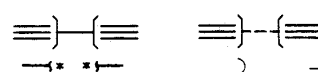
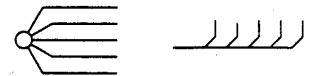
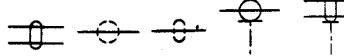
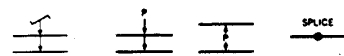
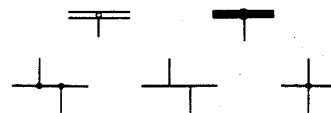

### 3.2 Distribution lines Transmission lines

F S T V



### 3.3 Alternative or Conditioned Wiring



### 3.4 Associated or Future



### 3.5 Intentional Isolation of Direct-Current Path in Coaxial or Waveguide Applications



3.6 Waveguide

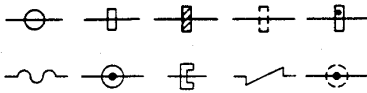

3.7 Strip-Type Transmission Line

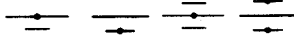

3.8 Termination

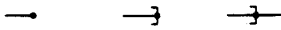

3.9 Circuit Return



3.10 Pressure-Tight Bulkhead Cable Gland Cable Sealing End



4. Contacts, Switches, Contactors, and Relays

4.1 Switching Function

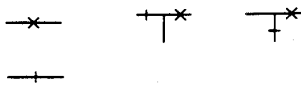

4.2 Electrical Contact

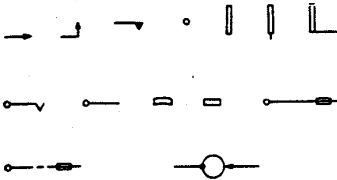

4.3 Basic Contact Assemblies

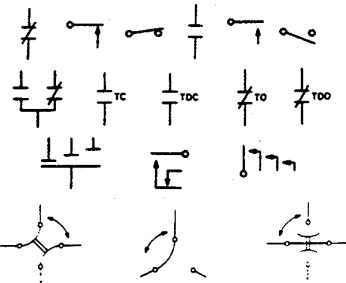

4.4 Magnetic Blowout Coil

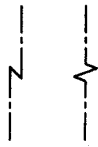

4.5 Operating Coil Relay Coil

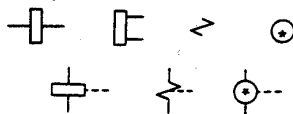

4.6 Switch

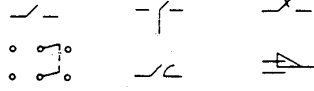

4.7 Pushbutton, Momentary or Spring-Return



4.8 Two-Circuit, Maintained or Not Spring-Return



4.9 Nonlocking Switch, Momentary or Spring-Return

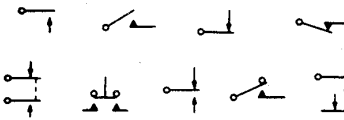

4.10 Locking Switch

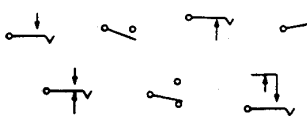

4.11 Combination Locking and Non-locking Switch



4.12 Key-Type Switch Lever Switch

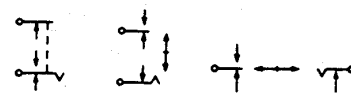

4.13 Selector or Multiposition Switch

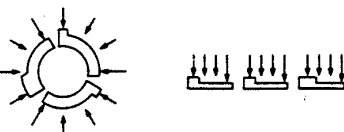
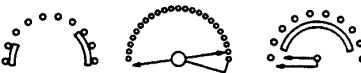
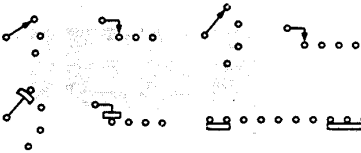

4.14 Limit Switch Sensitive Switch

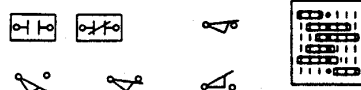

4.15 Safety Interlock

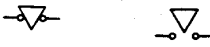

4.16 Switches with Time-Delay Features

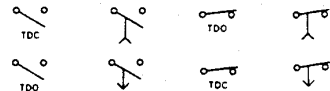

4.17 Flow-Actuated Switch



4.18 Liquid-Level-Actuated Switch



4.19 Pressure- or Vacuum-Actuated Switch



4.20 Temperature-Actuated Switch

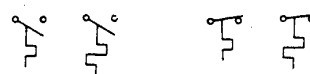

4.21 Thermostat



4.22 Flasher Self-interrupting switch

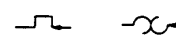

4.23 Foot-Operated Switch Foot Switch



4.24 Switch Operated by Shaft Rotation and Responsive to Speed or Direction

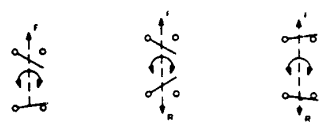

4.25 Switches with Specific Features

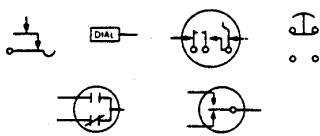

4.26 Telegraph Key



4.27 Governor Speed Regulator



4.28 Vibrator Interrupter

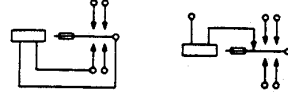

4.29 Contactor



4.30 Relay

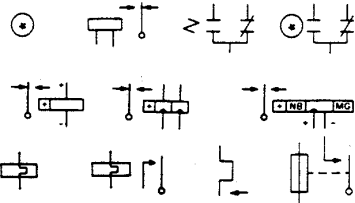
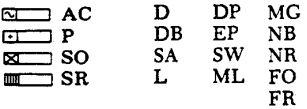

4.31 Inertia Switch



4.32 Mercury Switch



4.33 Aneroid Capsule



Terminals and Connectors

5.1 Terminals

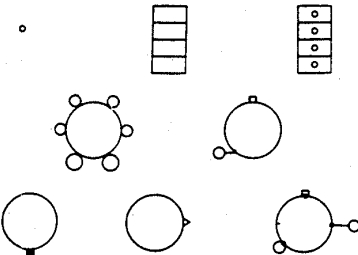

5.2 Cable Termination



5.3 Connector  
Disconnecting Device

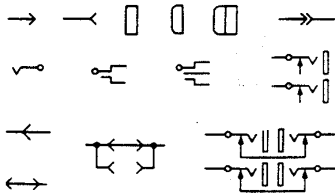

5.4 Connectors of the Type Commonly  
Used for Power-Supply Purposes

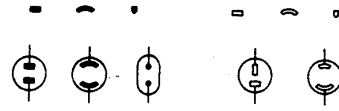

5.5 Test Blocks

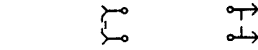

5.6 Coaxial Connector

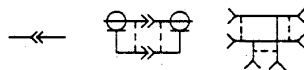

5.7 Waveguide Flanges  
Waveguide junction

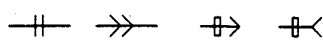

6. Transformers, Inductors, and  
Windings

6.1 Core

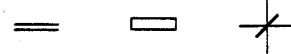

6.2 Inductor  
Winding  
Reactor  
Radio frequency coil  
Telephone retardation coil

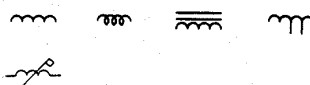

6.3 Transductor



6.4 Transformer  
Telephone induction coil  
Telephone repeating coil

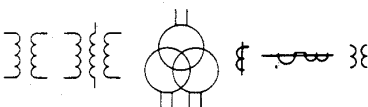
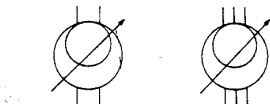
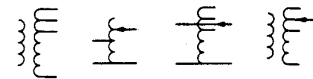
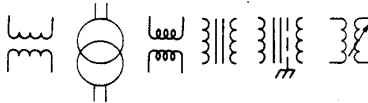

6.5 Linear Coupler



7. Electron Tubes and Related  
Devices

7.1 Electron Tube

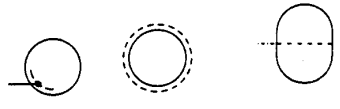
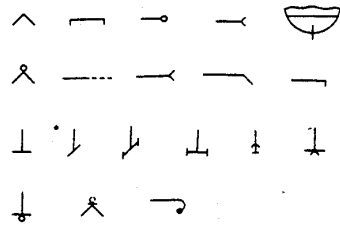

7.2 General Notes

7.3 Typical Applications

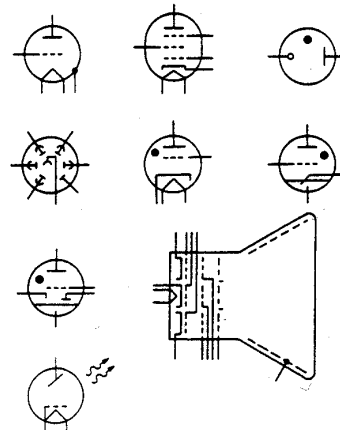

7.4 Solion  
Ion-Diffusion Device



7.5 Coulomb Accumulator  
Electrochemical Step-  
Function Device



7.6 Conductivity cell





**7.7 Nuclear-Radiation Detector**  
**Ionization Chamber**  
**Proportional Counter Tube**  
**Geiger-Müller Counter Tube**



**8. Semiconductor Devices**

**8.1 Semiconductor Device**  
**Transistor**  
**Diode**

**8.2 Element Symbols**

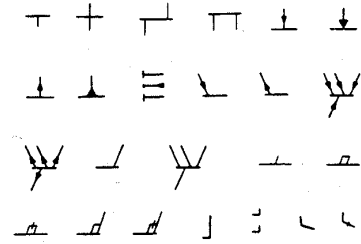

**8.3 Special Property Indicators**



**8.4 Rules for Drawing Style 1 Symbols**

**8.5 Typical Applications: Two-Terminal Devices**

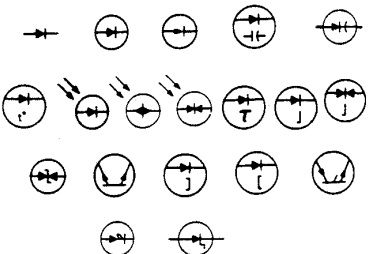

**8.6 Typical Applications: Three- (or More) Terminal Devices**

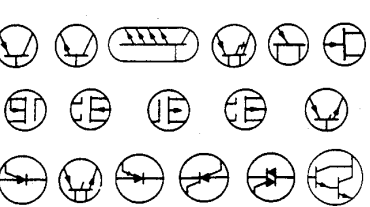

**8.7 Photosensitive Cell**



**8.8 Semiconductor Thermocouple**



**8.9 Hall Element**  
**Hall Generator**



**8.10 Photon-coupled isolator**



**8.11 Solid-state-thyatron**



**9. Circuit Protectors**

**9.1 Fuse**

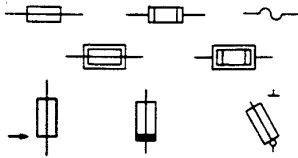

**9.2 Current Arrester**



**9.3 Lightning Arrester**  
**Arrester**  
**Gap**

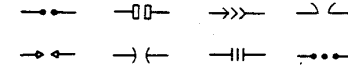

**9.4 Circuit Breaker**

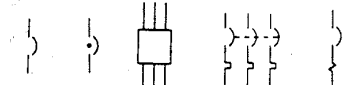

**9.5 Protective Relay**

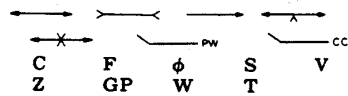

**10. Acoustic Devices**

**10.1 Audible-Signaling Device**

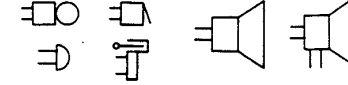

**10.2 Microphone**



**10.3 Handset**  
**Operator's Set**

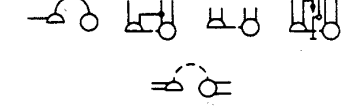

**10.4 Telephone Receiver**  
**Earphone**  
**Hearing-Aid Receivers**



**11. Lamps and Visual-Signaling Devices**

**11.1 Lamp**

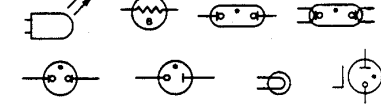

**11.2 Visual-Signaling Device**

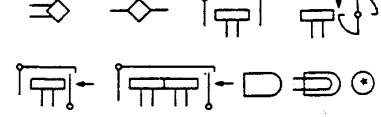

**12. Readout Devices**

**12.1 Meter**  
**Instrument**

A	DB	I	OP	RF	VA
AH	DBM	INT	OSCG	SY	VAR
C	DM	μA	PH	TLM	VARH
CM	DTR	UA	PI	t°	VI
CMC	F	MA	PF	THC	VU
CMV	G	NM	RD	TT	W
CRO	GD	OHM	REC	V	WH

**12.2 Electromagnetically Operated**  
**Counter**  
**Message Register**

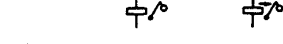

**13. Rotating Machinery**

**13.1 Rotating Machine**

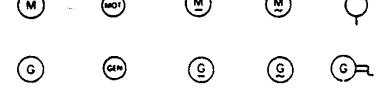

**13.2 Field, Generator or Motor**



**13.3 Winding Connection Symbols**



**13.4 Applications: Direct-Current**  
**Machines**

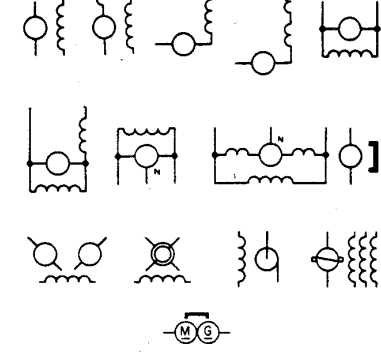

**13.5 Applications: Alternating-Current Machines**

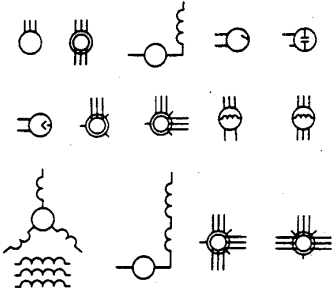

**13.6 Applications: Alternating-Current Machines with Direct-Current Field Excitation**

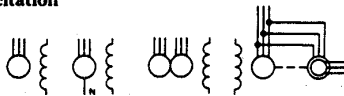

**13.7 Applications: Alternating- and Direct-Current Composite**

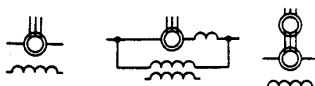

**13.8 Synchro**

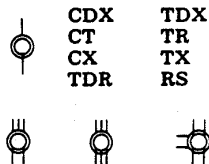

**14. Mechanical Functions**

**14.1 Mechanical Connection Mechanical Interlock**

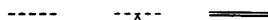

**14.2 Mechanical Motion**

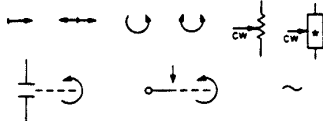

**14.3 Clutch Brake**

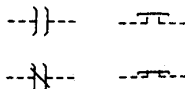

**14.4 Manual Control**

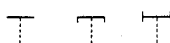

**15. Commonly Used in Connection with VHF, UHF, SHF Circuits**

**15.1 Discontinuity**

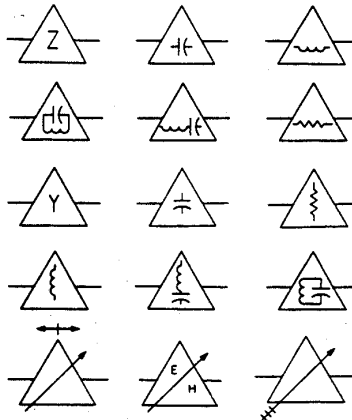

**15.2 Coupling**

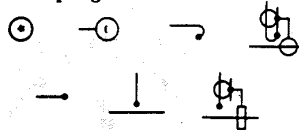

**15.3 Directional Coupler**

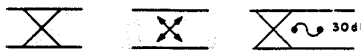

**15.4 Hybrid Directionally Selective Transmission Devices**



**15.5 Mode Transducer**



**15.6 Mode Suppression**



**15.7 Rotary Joint**



**15.8 Non-reciprocal devices**

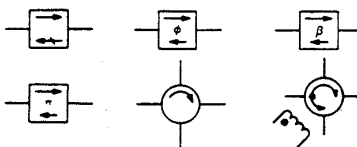

**15.9 Resonator Tuned Cavity**



**15.10 Resonator (Cavity Type) Tube**



**15.11 Magnetron**



**15.12 Velocity-Modulation (Velocity-Variation) Tube**



**15.13 Transmit-Receive (TR) Tube**

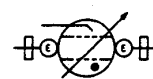

**15.14 Traveling-Wave-Tube**

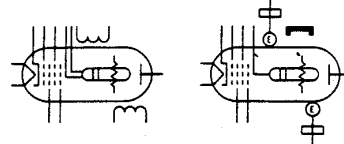

**15.15 Balun**



**15.16 Filter**

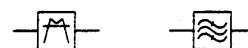

**15.17 Phase shifter**



**15.18 Ferrite bead rings**

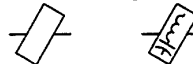

**15.19 Line stretcher**

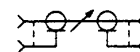

**16. Composite Assemblies**

**16.1 Circuit assembly**  
Circuit subassembly  
Circuit element

EQ	FL-BP	RG	TPR
FAX	FL-HP	RU	TTY
FL	FL-LP	DIAL	CLK
FL-BE	PS	TEL	IND
ST-INV			

**16.2 Amplifier**

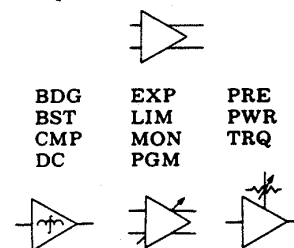

16.3 Rectifier



16.4 Repeater

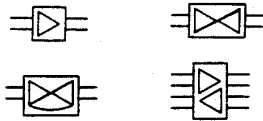

16.5 Network



16.6 Phase Shifter  
Phase-Changing Network



16.7 Chopper

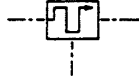

16.8 Diode-type ring demodulator  
Diode-type ring modulator



16.9 Gyro  
Gyroscope  
Gyrocompass



16.10 Position Indicator



16.11 Position Transmitter

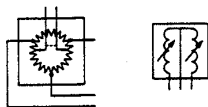

16.12 Fire Extinguisher Actuator Head

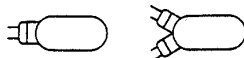

17. Analog Functions

17.1 Operational Amplifier



17.2 Summing Amplifier

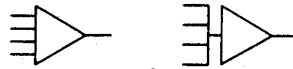

17.3 Integrator

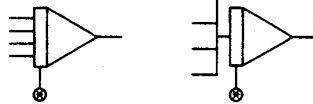

17.4 Electronic Multiplier



17.5 Electronic Divider



17.6 Electronic Function Generator



17.7 Generalized Integrator



17.8 Positional Servo-mechanism



17.9 Function Potentiometer



18. Digital Logic Functions

18.1 Digital Logic Functions  
(See cross references)

19. Special Purpose Maintenance  
Diagrams

19.1 Data flow code signals

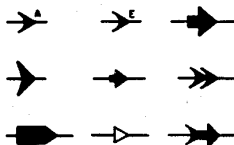

19.2 Functional Circuits

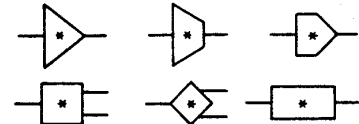

20. System Diagrams, Maps and  
Charts

20.1 Radio station

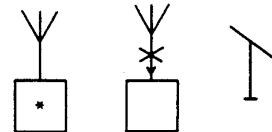

20.2 Space station

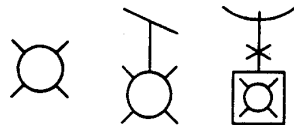

20.3 Exchange equipment

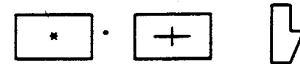

20.4 Telegraph repeater

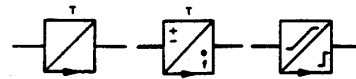

20.5 Telegraph equipment

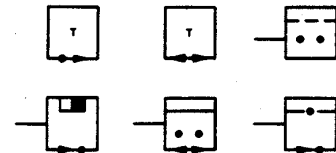

20.6 Telephone set

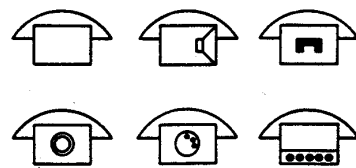

21. System Diagrams, Maps and  
Charts

21.1 Generating station



**21.2 Hydroelectric generating station**

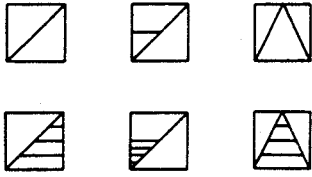

**21.3 Thermolectric generating station**

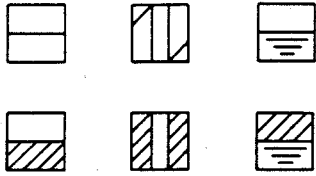

**21.4 Prime mover**



**21.5 Substation**



**22. Class Designation Letters**

A	DS	J	PU	TP
AR	E	K	Q	TR
AT	EQ	L	R	U
B	F	LS	RE	V
BT	FL	M	RT	VR
C	G	MG	RV	W
CB	H	MK	S	WT
CP	HP	MP	SQ	X
CR	HR	MT	SR	Y
D	HS	N	T	Z
DC	HT	P	TB	
DL	HY	PS	TC	

**IEEE Standard**  
**American National Standard**  
**Canadian Standard**

# **Graphic Symbols for Electrical and Electronics Diagrams**

**(Including Reference Designation Letters)**

## **Introduction**

### **A1. Scope**

#### **A1.1 Purpose**

This standard provides a list of graphic symbols and class designation letters for use on electrical and electronics diagrams.

#### **A1.2 Definition and Use**

Graphic symbols for electrical engineering are a shorthand used to show graphically the functioning or interconnections of a circuit. A graphic symbol represents the *function* of a part in the circuit.<sup>1</sup> Graphic symbols are used on single-line (one-line) diagrams, on schematic or elementary diagrams, or, as applicable, on connection or wiring diagrams. Graphic symbols are correlated with parts lists, descriptions, or instructions by means of designations.

The class designation letter portion of a reference designation is for the purpose of identifying an item by category or class, using a class letter as defined in Section 22 of this standard. The assignment of the reference designation should

---

<sup>1</sup>For example, when a lamp is employed as a nonlinear resistor, the nonlinear resistor symbol is used. For reference designation information, see Section 22 of this standard.

be in accordance with American National Standard Reference Designations for Electrical and Electronics Parts and Equipment, Y32.16-1975 (IEEE Std 200-1975).

## **A2. Arrangement**

### **A2.1 Indexing, Grouping, and Standard Item Names**

All terms appear in the Index. In the index, "Item" refers to a numbered paragraph in the list of symbols. Items are arranged sectionally in family groups by general type. Terms in preferred usage and current alternatives are listed. □ indicates item names from the Federal Item Identification Guide, Cataloging Handbook H6-1 (published by the Defense Supply Agency, Defense Logistics Services Center, Battle Creek, Michigan).

### **A2.2 Significance of Columnar Placement of Symbols**

In the list, graphic symbols appear under their respective family names. Symbols for single-line (one-line) diagrams appear at the left in each column; symbols for complete diagrams appear at the right. Symbols suitable for all types of diagrams appear in the center.

Symbols appearing only at the right may be used on one-line diagrams provided connections are restricted to main signal paths. Symbols appearing at the left may be used for other diagrams provided all connections are shown and adequate notations are included, if needed.

### **A2.3 IEC Identification**

Symbols and buildups using symbols that have been recommended by the International Electrotechnical Commission are indicated by IEC.

### **A2.4 Alternative Symbols**

When alternative symbols are shown, the relative position of the symbols does not imply a preference; however, alternative symbols identified as IEC are recommended.

## **A3. Application**

### **A3.1 Generation of Symbols Not Shown (Buildups)**

An application is an example of a combination of symbols in the list. No attempt has been made to list all possible applications (buildups); typical applications usually have been shown using only one of the possible alternatives. Additional applications may be devised using basic symbols in the list to complete the buildup, provided they are a reasonable and intelligible use of the symbols. If a specific symbol appears in this standard for an item, however, it shall be used in lieu of buildup symbols of the individual elements unless a clarification of the internal operation of the item is necessary.

### **A3.2 Qualifying Symbols (Section 1)**

Qualifying symbols may be added to symbols if the special characteristic is important to the function of the device and aids in the understanding of the over-all function performed. When the special characteristic represented by the qualifying symbol is not important to the over-all function performed, the qualifying symbol may be omitted from the buildup symbols which appear in this standard, provided the absence of the qualifying symbol will not change the identity of the item. For example, see symbol 2.1.12.1.1.

### A3.3 Application Data Reference

For application of these symbols on electrical diagrams, see American National Standard Drafting Practices; Electrical and Electronics Diagrams, Y14.15-1966 (R1973).

### A3.4 Graphic Symbols and Class Designation Letters Used in Existing Technical Documents

Unless otherwise specified, when revising an existing document use the most recently approved graphic symbols and reference designation class letters for any new symbols to be added to that document. Superseded symbols and reference designations already appearing in the document and in accordance with former additions of this standard may remain.

### A3.5 Similar or Identical Graphic Symbols, Letter Combinations, and Notations

Graphic symbols in this document may be similar or identical to symbols with different meanings used (1) in diverse fields within this standard or (2) in standards adopted by other technologies. Only one meaning shall apply to a specific symbol used on a diagram. If symbols having multiple meanings must be used on a diagram the possibility of conflicts and misinterpretations can be minimized by the liberal use of caution notes, asterisks, and flagging techniques; a tabulation listing the intended meanings should be provided. This requirement is especially critical if the graphic symbols used are from different disciplines and therefore represent devices, conductors, or lines of flow that if misinterpreted may result in damage to the equipment or be hazardous to the life of servicing or operating personnel.

## A4. Drafting Practices Applicable to Graphic Symbols

### A4.1 Definitions

**A4.1.1 *Single-Line (One-Line) Diagram:*** A diagram which shows, by means of single lines and graphic symbols, the course of an electric circuit or system of circuits and the component devices or parts used therein.

**A4.1.2 *Schematic or Elementary Diagram:*** A diagram which shows, by means of graphic symbols, the electrical connections and functions of a specific circuit arrangement. The schematic diagram facilitates tracing the circuit and its functions without regard to the actual physical size, shape, or location of the component device or parts.

**A4.1.3 *Symbol:*** A symbol shall be considered as the aggregate of all its parts.

### A4.2 Orientation

Except where noted, the orientation of a symbol on a drawing, including a mirror-image presentation, does not alter the meaning of the symbol. Letters and numbers that constitute a part of a symbol shall not be presented in mirror-image form.

### A4.3 Line Width

The width of a line does not affect the meaning of the symbol. In specific cases, a wider (heavier) line may be used for emphasis.

### A4.4 Enlargement or Reduction

A symbol may be drawn to any proportional size that suits a particular drawing, depending on reduction or enlargement anticipated. If essential for purposes of contrast, some symbols may be drawn relatively smaller than the other symbols on a diagram. It is recommended that only two sizes be used on any one diagram.

### A4.5 Relative Symbol Size<sup>2</sup>

The symbols shown in this edition of the standard are in their correct relative size. This relationship shall be maintained as nearly as possible on any particular drawing, regardless of the size of the symbol used.

### A4.6 Arrowheads

The arrowhead of a symbol may be closed  $\rightarrow$  or open  $\rightarrow$  unless otherwise noted in this standard.

### A4.7 Terminal Symbols

The standard symbol for a TERMINAL (o) may be added to each point of attachment of connecting lines to any one of the graphic symbols. Such added terminal symbols should not be considered as part of the individual graphic symbol, unless the terminal symbol is included in the symbol shown in this standard.

### A4.8 Correlation of Symbol Parts

For simplification of a diagram, parts of a symbol for a device, such as a relay or contactor, may be separated. If this is done, provide suitable designations to show proper correlation of the parts.

### A4.9 Angle of Connecting Lines

In general, the angle at which a connecting line is brought to a graphic symbol has no particular significance unless otherwise noted or shown in this standard.

### A4.10 Future or Associated Paths and Equipment

Associated or future paths and equipment shall be shown by lines composed of short dashes:- - -. For example:



### A4.11 Envelope or Enclosure

#### A4.11.1

The envelope or enclosure symbol shall be used:

- a) If the enclosure has an essential operating function, as in an electron tube, solion, switch in an evacuated envelope, etc.

<sup>2</sup>The symbols shown in this edition of the standard are larger in size than those shown in the 1967 edition. All of the symbols have been prepared so that the connection points are located at intersections of a modular (incremental) grid.

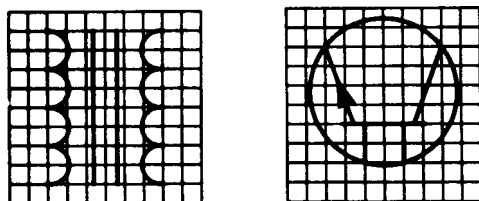



- b) If the device envelope is electrically connected to one of the device elements and this is an essential (not merely incidental) functional property of the device.

#### A4.11.2

The envelope or enclosure symbol should be used:

- a) To emphasize that certain symbols having nonconnected lines are a single assembly (for example, see symbol 8.6.10.5).
- b) If it is desired to distinguish a class of devices, such as transistors or semiconductor controlled rectifiers, from other devices (but this should be consistent for all devices of the same class on any one diagram).
- c) To associate the parts of symbols having adjacent characteristic qualifiers (for example:  $t^\circ$ ,  $\tau$ ,  $\omega$ ,  $\times$ ).

#### A4.11.3

The envelope or enclosure symbol may be omitted from a symbol referencing this paragraph, where confusion would not result (but this should be consistently applied to all symbols of the same class in any one diagram).

### A4.12 Addition of Supplementary Data

Details of type, impedance, rating, etc, may be added adjacent to any symbol, when required. If used, abbreviations should be from American National Standard Abbreviations for Use on Drawings and in text, Y1.1-1972. For military applications, see Section 23. Letter combinations used as parts of graphic symbols are not abbreviations or designations.

Recommendations for corrections and additions to or deletions from this standard should be sent to the Secretary, IEEE Standards Board, Institute of Electrical and Electronics Engineers, 345 East 47 Street, New York, N.Y. 10017, and should include the following:

- 1) Requestor (name, address, affiliation)
- 2) Reason for (and urgency of) request
- 3) Item name—list all known names for the item, including tradenames (include Federal Item Identification Guide, Handbook H6-1, listing if applicable)
- 4) Item definition (list source documents)
- 5) Symbols currently in use or known to be used (single-line/schematic/both)
- 6) Proposed symbol
- 7) Reference designation class designation letter
- 8) Areas of application (military/industry/commercial)
- 9) Fields of application (computer/power/radio, etc)
- 10) Circuit application (amplifier/rectifier/flip-flop, etc)
- 11) Hardware characteristics (microcircuit/conventional, etc)
- 12) Present and anticipated frequency of use (per circuit/per equipment/in general)
- 13) Copy of drawing showing use of symbol

## 1. Qualifying Symbols

### 1.1 Adjustability Variability

These recognition symbols shall be drawn at about 45 degrees across the body of symbol to which they are applied. For typical applications, see symbols 2.1.5, 2.2.4, 2.4.4, and 16.2.5.

Use only if essential to indicate special property.

NOTES:

- 1 — See introduction for general information (note especially A3.1).
- 2 — Symbols for single-line (one-line) diagrams appear at the left, symbols for complete diagrams at the right, and symbols suitable for both purposes are centered in each column.
- 3 — For centered figures with symbols appearing side by side, the symbol on the left-hand side should be considered to be for a single line (one-line) diagram and the symbol on the right-hand side for a complete diagram, i.e., 1.5.1.

**1.1.1 Adjustability (extrinsic adjustability)**

**1.1.1.1 General**

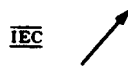

**1.1.1.2 Preset, general**

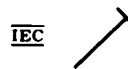

**1.1.1.3 Linear (shown applied to 1.1.1.1)**



**1.1.1.4 Nonlinear (shown applied to 1.1.1.1)**

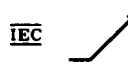

**1.1.2 Inherent variability (intrinsic variability)**

**1.1.2.1 Linear**

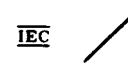

**1.1.2.2 Nonlinear**

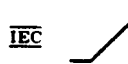

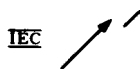
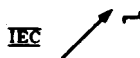
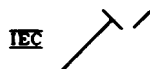
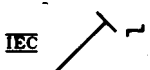
**1.1.3 Special features (shown applied to the general adjustability symbol)****1.1.3.1 Continuous****1.1.3.2 In steps****1.1.4 Special features (shown applied to the general preset symbol)****1.1.4.1 Continuous****1.1.4.2 In steps****1.2 Special-Property Indicators**

A special function or property essential to circuit operation shall be indicated by a supplementary symbol placed within the envelope or adjacent to the symbol.

NOTE — 1.2A: Basic symbols (such as resistor, capacitor, inductor, piezoelectric crystal, etc) may be used as qualifying symbols to other symbols for purposes of indicating special properties of the device.

**1.2.1 Temperature dependence****1.2.2 Magnetic-field dependence****1.2.3 Storage (Greek letter tau)**

**1.2.4 Saturable properties (general)**

May be drawn between or across two or more windings (see symbol 6.3.1) that are magnetically coupled by a saturable core.

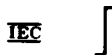
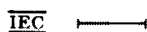
**1.2.5 Delay****1.3 Radiation Indicators (electromagnetic and particulate)**

Use only if essential to indicate special property.

**NOTES:**

1.3A — Arrows pointing toward a symbol denote that the device symbolized will respond to incident radiation of the indicated type.

1.3B — Arrows pointing away from a symbol denote the emission of the indicated type of radiation by the device symbolized.

1.3C — Arrows located within a symbol denote a self-contained radiation source.

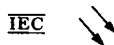
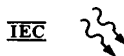
**1.3.1 Radiation, nonionizing, electromagnetic (e.g., radio waves or visible light)****1.3.2 Radiation, ionizing**

NOTE — 1.3.2A: If it is necessary to show the specific type of ionizing radiation, the symbol may be augmented by the addition of symbols or letters such as the following IEC:

Alpha particle	$\alpha$
Beta particle	$\beta$
Gamma ray	$\gamma$
Deuteron	d
Proton	p
Neutron	n
Pion	$\pi$
K-meson	$\tau$
Muon	K
X-ray	X

## 1.4 Physical State Recognition Symbols

NOTE — 1.4A: The rectangle is not part of the symbol.

### 1.4.1 Gas (air); pneumatic

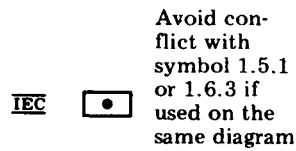

See Note 1.4A

### 1.4.2 Liquid



See Note 1.4A

### 1.4.3 Solid



See Note 1.4A

### 1.4.4 Showing two or more states

Use only if essential to indicate special condition.

#### NOTES:

1.4.4A — A combination of physical state recognition symbols indicates a material in more than one state. The relative sizes and locations of the recognition symbols indicate the normal or predominant state of the device.

1.4.4B — Do not rotate or show in mirror-image form.

#### 1.4.4.1 Application: Gaseous liquid



See Notes 1.4.4A and B

#### 1.4.4.2 Application: Steam (or moist gas)



See Notes 1.4.4.A and B

### 1.4.5 Electret material



## 1.5 Test-Point Recognition Symbol

Used if necessary to emphasize test points.

NOTE — 1.5A: If other types of symbols (such as, stars, numbered circles, etc.) are substituted for the test-point recognition symbol, they shall be explained on the diagram or referenced document.

### 1.5.1 General

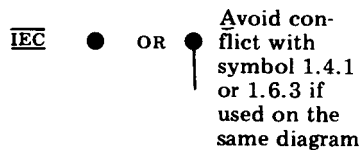

### 1.5.2 Application: test-point recognition for a test jack

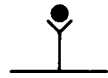

### 1.5.3 Application: test-point recognition for the plate of a triode

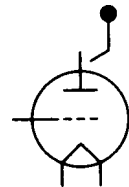

### 1.5.4 Application: test-point recognition for a circuit terminal



## 1.6 Polarity Markings

### 1.6.1 Positive



1.6.2 Negative

IEC -

1.6.3 Instantaneous polarity markings

These polarity marks shall be used only when it is necessary to show the relative polarity of the windings.

NOTES:

1.6.3A — Instantaneous polarity of voltage across windings corresponds at points indicated by polarity marks. Instantaneous direction of current into (or out of) one polarity mark corresponds to current out of (or into) the other polarity mark. If instantaneous currents enter the windings at the marked points, they will produce aiding fluxes.

1.6.3B — The polarity marks shall be placed near one end of each coil or winding symbol. The exact location is immaterial as long as they are unambiguously placed, especially where other windings are drawn nearby. There shall be only one polarity mark per winding, even if the winding is tapped. The following is NOT permitted:

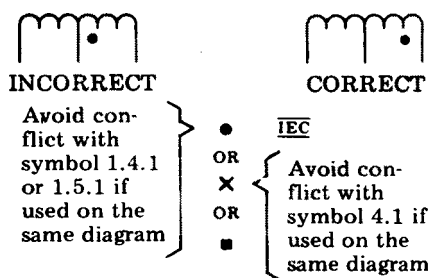

1.6.3.1 Application: instantaneous polarity markings with current transformer shown

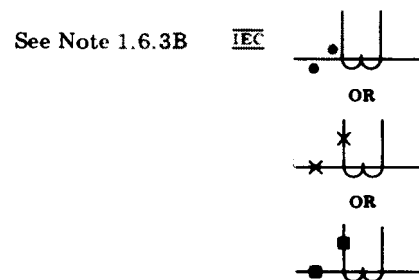

1.6.3.2 Application: instantaneous polarity markings with potential transformer shown

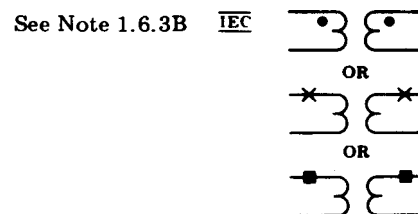

## 1.7 Direction of Flow of Power, Signal, or Information

Avoid conflict with symbols 9.5, 9.5.2, and 9.5.4 if used on the same diagram

### 1.7.1 One-way

NOTE — 1.7.1A: The lower symbol is used if it is necessary to conserve space. The arrowhead in the lower symbol shall be filled.

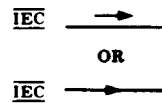

See Note 1.7.1A

### 1.7.2 Either way (but not simultaneously)

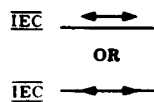

See Note 1.7.1A

### 1.7.3 Both ways, simultaneously

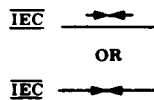

See Note 1.7.1A

Avoid conflict with symbol 9.2 if used on the same diagram

### 1.7.4 Application: one-way, general

NOTE — 1.7.4A: The “n” is not part of the symbol. A significant waveform, frequency, or frequency range shall be substituted for “n.”

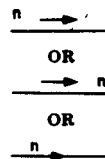

See Note 1.7.4A



**1.7.5** Application: one-way circuit element, general

NOTE — 1.7.5A: In all cases, indicate the type of apparatus by appropriate words or letters in the rectangle.

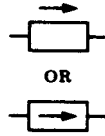

See Note 1.7.5A

**1.8 Kind of Current (General)**

NOTE — 1.8A: Use only if necessary for clarity.

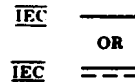
**1.8.1** Direct current

To be used in cases when other symbol is not suitable

**1.8.2** Alternating current**1.8.3** Alternating current, frequency ranges

Use only if necessary to distinguish among different frequency bands.

NOTES:

1.8.3A — The “n” is not part of the symbol. The frequency range shall be substituted for “n.”

1.8.3B — Only one name for the unit of frequency (hertz or cycle per second) should be used on any one diagram.

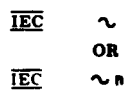
**1.8.3.1** Power frequencies

See Notes 1.8.3.A and B

**1.8.3.2** Audio frequencies

IEC   
OR

IEC 

See Notes 1.8.3A and B

**1.8.3.3** Superaudio, carrier, and radio frequencies

IEC   
OR

IEC 

See Notes 1.8.3A and B

**1.8.4** Direct or alternating current (universal)

IEC 

**1.8.5** Undulating or rectified current

IEC 

**1.9 Connection Symbol**

For use adjacent to the symbols; e.g., see symbols 6.4.15.1 and 13.3.

**1.9.1** 2-phase 3-wire, ungrounded

IEC 

**1.9.1.1** 2-phase 3-wire, grounded

IEC 

**1.9.2** 2-phase 4-wire



OR

IEC 

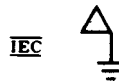
**1.9.2.1** 2-phase 5-wire, grounded**1.9.3** 3-phase 3-wire, delta or mesh**1.9.3.1** 3-phase 3-wire, delta, grounded**1.9.4** 3-phase 4-wire, delta, ungrounded**1.9.4.1** 3-phase 4-wire, delta, grounded**1.9.5** 3-phase, open-delta**1.9.5.1** 3-phase, open-delta, grounded at common point**1.9.5.2** 3-phase, open-delta, grounded at middle point of one winding

**1.9.6** 3-phase, broken-delta**1.9.7** 3-phase, wye or star, ungrounded**1.9.7.1** 3-phase, wye, grounded neutral

The direction of the stroke representing the neutral can be chosen arbitrarily.

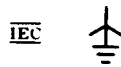
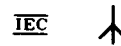
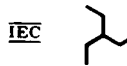
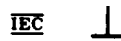
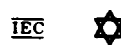
**1.9.8** 3-phase 4-wire, ungrounded**1.9.9** 3-phase, zigzag, ungrounded**1.9.9.1** 3-phase, zigzag, grounded**1.9.10** 3-phase, Scott or T**1.9.11** 6-phase, double-delta

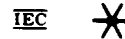
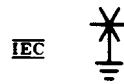
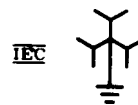
**1.9.12** 6-phase, hexagonal (or chordal)**1.9.13** 6-phase, star (or diametrical)**1.9.13.1** 6-phase, star, with grounded neutral**1.9.14** 6-phase, double zigzag with neutral brought out and grounded**1.10 Envelope Enclosure**

The general envelope symbol identifies the envelope or enclosure regardless of evacuation or pressure. When used with electron-tube component symbols, the general envelope symbol indicates a vacuum enclosure unless otherwise specified. A gas-filled device may be indicated by a dot within the envelope symbol.

See paragraph A4.11.1 of the Introduction

NOTE — 1.10A: The shape of the envelope symbol may be modified to approximate the distinctive shape of a device if the shape will aid in recognition of the device, or in depicting the device function, e.g., cathode-ray tube, iconoscope, image orthicon, vidicon, X-ray tube, etc. For typical applications, see symbols 7.3.6.1 and 7.3.6.2.2.

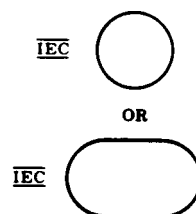
**1.10.1** General

**1.10.2 Split envelope**

If necessary, envelope may be split.

**1.10.3 Application: gas-filled envelope**

The gas-recognition symbol (dot) may be located as convenient. See symbol 1.4.1

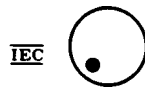
**1.10.4 Application: liquid-filled envelope**

The liquid-recognition symbol may be located as convenient. See symbol 1.4.2

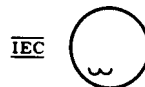
**1.11 Shield Shielding**

Normally used for electric or magnetic shielding.

NOTE — 1.11.1A: If essential to show type of shielding add E for electric and M for magnetic shielding.

When used for other shielding, a note should so indicate. For typical applications see

CAPACITOR (symbol 2.2.3)

TRANSMISSION PATH (symbols 3.1.8.1, 3.1.8.2, and 3.1.8.3)

TRANSFORMER (symbols 6.4.2.2 and 6.4.2.3)

**1.11.1 General**

These are long dashes.



### 1.11.2 Optical



## 1.12 Special Connector or Cable Indicator

### NOTES:

1.12A — If it is essential to denote on a system-type interconnection wiring diagram that the connector or cable is furnished with the equipment by the equipment manufacturer the following symbol shall be used.

1.12B— It is recommended that the symbol be drawn using a 0.20 inch diameter circle.



## 1.13 Electret (shown with electrodes)

NOTE — 1.13A: The longer line represents the positive pole.

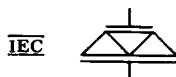

## Cross References

See also Section 19.

### NOTES:

- 1 — See Introduction for general information (note especially A3.1).
- 2 — Symbols for single-line (one-line) diagrams appear at the left, symbols for complete diagrams at the right, and symbols suitable for both purposes are centered in each column.
- 3 — For centered figures with symbols appearing side by side, the symbol on the left-hand side should be considered to be for a single line (one-line) diagram and the symbol on the right-hand side for a complete diagram, i.e., 1.5.1.

## 2. Graphic Symbols for Fundamental Items (not included in other sections)

### 2.1 Resistor

For resistors with nonlinear characteristics, see also BALLAST LAMP (symbol 11.1.5)

NOTE — 2.1A: The asterisk is not part of the symbol. Always add identification within or adjacent to the rectangle.

## 2.1.1 General

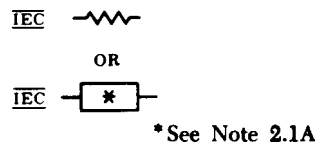

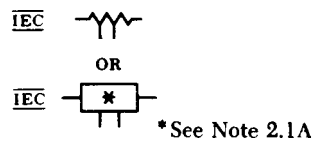

## 2.1.2 Tapped resistor

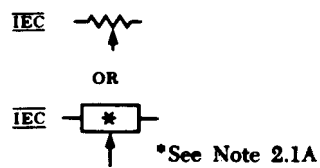

## 2.1.3 Application: with adjustable contact. See also symbol 14.2.5

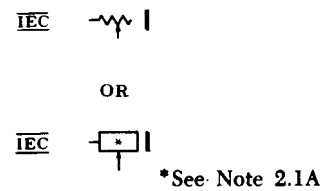

## 2.1.3.1 Application: with adjustable contact and OFF (disconnect) position

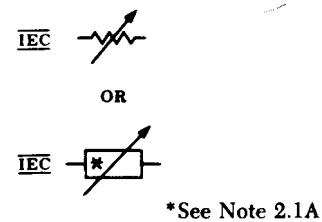
2.1.4 Application: adjustable or continuously adjustable (variable) resistor ; rheostat

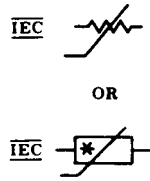

**2.1.5** Nonlinear resistor (intrinsic)

OR

\*See Note 2.1A

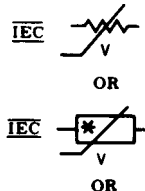
**2.1.6** Symmetrical varistor (intrinsic); voltage-sensitive resistor  $\square$  (silicon carbide, etc)

OR

\*See Note 2.1A

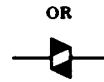

OR

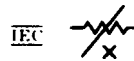
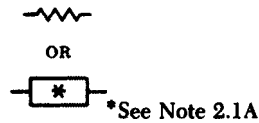
**2.1.7** Magnetoresistor (intrinsic) (linear type shown)**2.1.8** Heating resistor

OR

\*See Note 2.1A

**2.1.9** Instrument or relay shunt

Connect instrument or relay to terminals in the rectangle

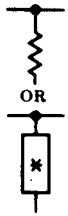

**2.1.10 Shunt resistor**

\* See Note 2.1A

**2.1.11 Resistive termination**

Commonly used in coaxial and waveguide diagrams.

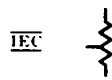
**2.1.11.1 Application: series resistor and path open****2.1.11.2 Application: series resistor and path short-circuited****2.1.11.3 Bolometer element ( - - - lines indicate direct-current connections and are not part of the symbol)****2.1.12 Thermistor; thermal resistor  $\square$ ; temperature-sensing element**

NOTE — 2.1.12A: Use only if essential to indicate special characteristic.

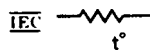
**2.1.12.1 General**

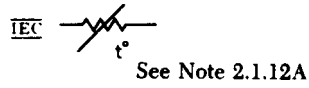
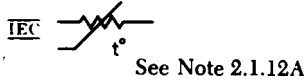
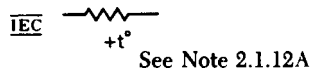
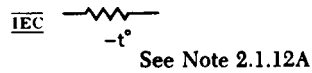
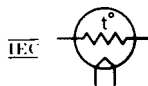
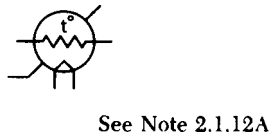
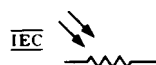
**2.1.12.1.1** Linear**2.1.12.1.2** Nonlinear**2.1.12.1.3** Positive temperature coefficient**2.1.12.1.4** Negative temperature coefficient**2.1.12.2** With independent integral heater**2.1.12.2.1** Nonlinear**2.1.13** Symmetrical photoconductive transducer (resistive)

## 2.2 Capacitor

### NOTES:

2.2A — Capacitors may be represented by either of two methods. For convenience in referring to the capacitor symbols in this section, they are classified as follows:

Style 1 symbols are drawn with two parallel lines (IEC preferred).

Style 2 symbols are drawn with one straight and one curved line.

2.2B — Where there is only one style shown and reference is made to the general symbol 2.2.1, this indicates that either style may be used, as modified for that particular application.

2.2C — The distance between the plates shall be between one-fifth and one-third of the length of a plate. IEC

### 2.2.1 General

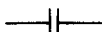
Style 1  IEC

OR

Style 2  IEC

#### 2.2.1.1 With identified electrode

##### NOTES:

2.2.1.1A — For style 1, if it is necessary to identify the capacitor electrodes, the modified element shall represent the outside or lower potential electrode. IEC

2.2.1.1B — For style 2, if it is necessary to identify the capacitor electrodes, the curved element shall represent:

- The outside electrode in fixed paper-dielectric and ceramic-dielectric capacitors;
- The moving element in adjustable and variable capacitors;
- The low-potential element in feed-through capacitors. IEC

See General Symbols 2.2.1 and Note 2.2B

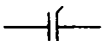
Style 1  IEC

OR

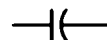
Style 2  IEC

See Note 2.2.1.1B

**2.2.2 Polarized capacitor**

See General Symbols 2.2.1 and Note 2.2B

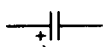
Style 1  IEC

OR

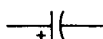
Style 2 

**2.2.3 Shielded capacitor**

See General Symbols 2.2.1 and Note 2.2B

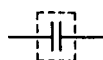
 IEC

**2.2.4 Adjustable or variable capacitors**

NOTE — 2.2.4A: If it is necessary to identify trimmer capacitors, the letter T should appear adjacent to the symbol.



See General Symbols 2.2.1 and Note 2.2B

**2.2.4.1 With moving element indicated**

 IEC

NOTE — 2.2.4.1A: If it is desired to indicate the moving element, the common intersection of the moving element with the symbol for variability and the connecting line is marked with a dot. IEC

See General Symbols 2.2.1 and Note 2.2B

IEC  OR  IEC  
Style 1 OR Style 2

**2.2.5 Application: adjustable or variable capacitors with mechanical linkage of units**

See General Symbols 2.2.1 and Note 2.2B

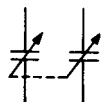
 IEC

**2.2.6** Continuously adjustable or variable differential capacitor

The capacitance of one part increases as the capacitance of the other part decreases. See General Symbols 2.2.1 and Note 2.2B

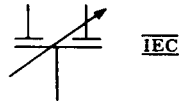
**2.2.7** Phase-shifter capacitor

See General Symbols 2.2.1 and Note 2.2B

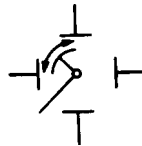
**2.2.8** Split-stator capacitor

The capacitances of both parts increase or decrease simultaneously. See General Symbols 2.2.1 and Note 2.2B

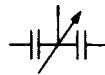
**2.2.9** Feed-through capacitor

Commonly used for bypassing high-frequency currents to chassis.

NOTE — 2.2.9A: For purposes of clarity, terminals may be shown on the feed-through element.

See General Symbols 2.2.1 and Note 2.2B

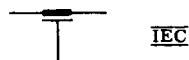
**2.2.9.1** Application: feed-through capacitor between two inductors with third lead connected to chassis

See General Symbols 2.2.1 and Note 2.2B



**2.2.10** Capacitive termination

Commonly used on coaxial and wave-guide diagrams.

**2.2.10.1** Application: series capacitor and path open

See General Symbols 2.2.1 and Note 2.2B

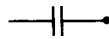
**2.2.10.2** Application: series capacitor and path short-circuited

See General Symbols 2.2.1 and Note 2.2B

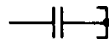
**2.2.11** Shunt capacitor**2.2.12** Coupling capacitor (for power-line carrier)

NOTE — 2.2.12A: The asterisk is not part of the symbol. If specific identifications is desired, the asterisk is to be replaced by one of the following letter combinations:

COM	Carrier communication
LC	Carrier load control
REL	Carrier relaying
SUP	Carrier supervisory
TLM	Carrier telemetering
TT	Carrier transferred trip

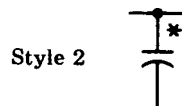

**\*See Note 2.2.12**

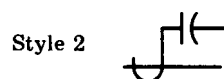
**2.2.13** Capacitor bushing for circuit breaker or transformer

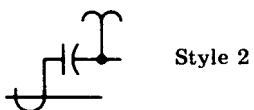
**2.2.14** Application: capacitor-bushing potential device**2.2.15** Application: carrier-coupling capacitor potential device (used to provide a power-system-frequency voltage and also coupling for carrier signals)

NOTE — 2.2.15A: The dagger is not part of the symbol. If specific indication is desired, the dagger is to be replaced by a letter combination from item 12.1, Note 12.1A.

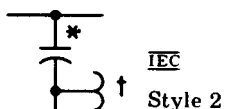

\*See Note 2.2.12A

†See Note 2.2.15A

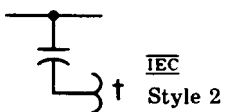
**2.2.16** Application: coupling capacitor potential device (used only to provide a power-system-frequency voltage)

†See Note 2.2.15

**2.3 Antenna** F**2.3.1** General

Types of functions may be indicated by words or abbreviations adjacent to the symbol.

Qualifying symbols may be added to the antenna symbol to indicate polarization, direction of radiation, or special application.

If required, the general shape of the main lobes of the antenna polar diagrams may be shown adjacent to the symbol. Notes may be added to show the direction and rate of lobe movement.

The stem of the symbol may represent any type of balanced or unbalanced feeder, including a single conductor.

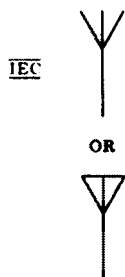



**2.3.1.1** Application: turnstile antenna

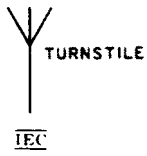

**2.3.2** Dipole

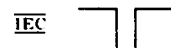

**2.3.3** Loop

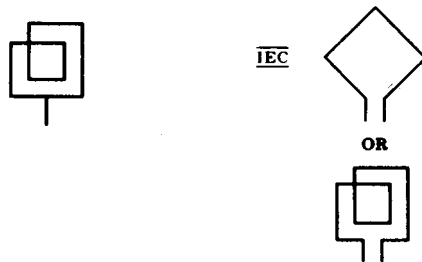

**2.3.4** Antenna counterpoise

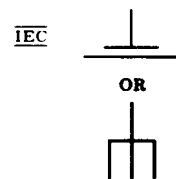

**2.3.5** Qualifying symbols to indicate polarization

Use only if essential to indicate special property of an antenna.

**2.3.5.1** Plane polarization

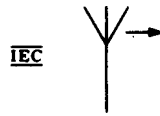
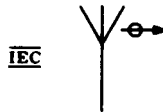

**2.3.5.2** Application: antenna with horizontal polarization**2.3.5.3** Application: antenna with vertical polarization**2.3.5.4** Circular polarization**2.3.5.5** Application: antenna with circular polarization**2.3.6** Qualifying symbols to indicate direction of radiation

Use only if essential to indicate special property of an antenna.

## NOTES:

2.3.6A — Any applicable adjustability symbol (item 1.1) may be used to supplement a qualifying symbol.

2.3.6B — Antenna rotation can be accomplished by electromechanical or electronic means.

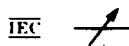
**2.3.6.1** Fixed in azimuth**2.3.6.2** Adjustable in azimuth

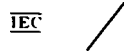
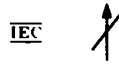
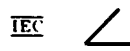
**2.3.6.3** Fixed in elevation**2.3.6.4** Adjustable in elevation**2.3.6.5** Fixed in azimuth and elevation**2.3.6.6** Direction finder, radio goniometer or beacon**2.3.6.7** Rotation

See symbols 14.2.3, 14.2.4 and 14.2.4.1; see Note 2.3.6B

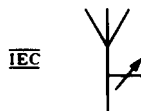
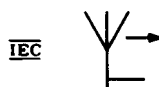
**2.3.7** Application: antenna with qualifying symbols and notes**2.3.7.1** Antenna with direction of radiation fixed in azimuth**2.3.7.2** Antenna with direction of radiation adjustable in azimuth**2.3.7.3** Antenna with direction of radiation fixed in azimuth, horizontal polarization

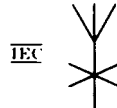
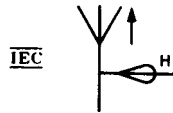
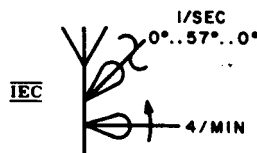
**2.3.7.4** Antenna with adjustable directivity in elevation**2.3.7.5** Direction finding, radio goniometer, or radio beacon antenna**2.3.7.6** Antenna with direction of radiation fixed in azimuth, vertically polarized, with horizontal polar diagram**2.3.7.7** Radar antenna, rotating 4 times per minute in azimuth and reciprocating in elevation, 0° to 57° to 0° in one second

See Note 2.3.6B

**2.4 Attenuator****2.4.1** Fixed attenuator  $\square$ ; pad (general)**2.4.2** Balanced, general

**2.4.3 Unbalanced, general****2.4.4 Variable attenuator  $\overline{\text{F}}$  (general)****2.4.5 Balanced, general****2.4.6 Unbalanced, general****2.5 Battery**

The long line is always positive, but polarity may be indicated in addition. Example:

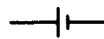
**2.5.1 Generalized direct-current source****2.5.2 One cell****2.5.3 Multicell**

**2.5.4 Multicell battery with 3 taps**

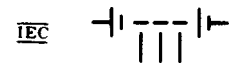

**2.5.5 Multicell battery with adjustable tap**

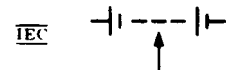

**2.6 Delay Function**

**Delay Line  $\square$   
Slow-Wave Structure**

**2.6.1 Delay element, general**

NOTES:

2.6.1A — Length of delay may be indicated. Asterisk is not part of symbol.

2.6.1B — The two vertical lines indicate input side.

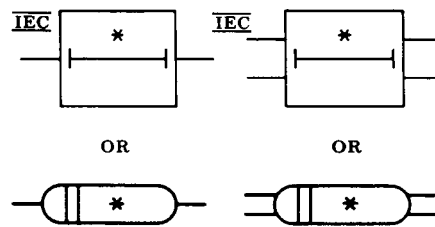

\*See Note 2.6.1A

**2.6.2 Tapped delay element**

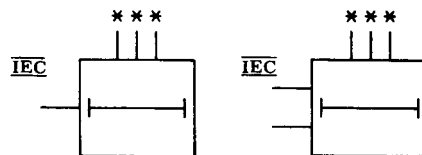

\*See Note 2.6.1A and general symbols 2.6.1

**2.6.3 Variable delay element**

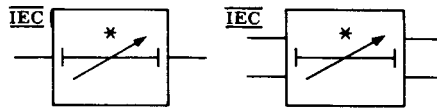

\*See Note 2.6.1A and general symbols 2.6.1

**2.6.4 Slow-wave structure**

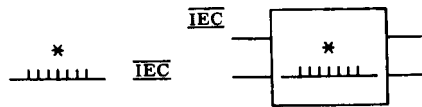

\*See Note 2.6.1A

**2.7 Oscillator  
Generalized Alternating-Current Source**



**2.8 Permanent Magnet**  



**2.9 Pickup  
Head**

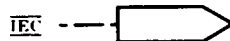

**2.9.1** <sup>3</sup> General

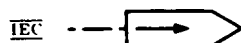

**2.9.2** <sup>3</sup> Writing; recording; head, sound-recorder  

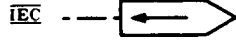
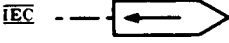
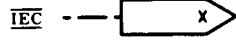
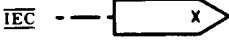
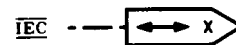
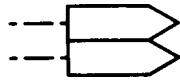

<sup>3</sup>The broken line - - - indicates where line connection to a symbol is made and is not part of the symbol.

**2.9.3**<sup>4</sup> Reading; playback; head, sound-reproducer **2.9.4**<sup>4</sup> Erasing; magnetic eraser **2.9.5**<sup>4</sup> Application: writing, reading, and erasing**2.9.6**<sup>4</sup> Stereo**2.10 Piezoelectric Crystal Unit (including Crystal Unit, Quartz  )****2.11 Transducer ****Accelerometer ****Motional Pickup Transducer **

Use only if a more specific symbol is not applicable, e.g., tachometer generator, microphone, motor, loudspeaker, etc.

For other measuring transducers, see Hall Generator (8.9) and Thermal Converter (12.1)

**2.11.1** General, electrical output

<sup>4</sup>The broken line - - - indicates where line connection to a symbol is made and is not part of the symbol.



## 2.12 Squib, Electric

### 2.12.1 Explosive

### 2.12.2 Igniter



### 2.12.3 Sensing link; fusible link, ambient-temperature operated

Avoid conflict with symbol 3.6.4 if used on the same diagram



## 2.13 Thermocouple (dissimilar-metals device)

### 2.13.1 Temperature-measuring

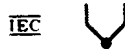

### 2.13.2 Current-measuring

NOTE — 2.13.2A: Explanatory words and arrows are not part of the symbols shown.

#### 2.13.2.1 With integral heater internally connected



#### 2.13.2.2 With integral insulated heater

See paragraph A4.11 of the introduction



**2.13.3 Thermopile****2.14 Thermal Element  
Thermomechanical Transducer**

Actuating device, self-heating or with external heater. (Not operated primarily by ambient temperature.) See item 9.1 for fuses, one-time devices. See item 4.30.5 for thermally operated relay.

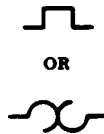
**2.15 Spark Gap  
Igniter Gap**

USE SYMBOL 9.3.1

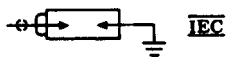
**2.16 Continuous Loop Fire Detector (temperature sensor)****2.17 Ignitor Plug****Cross References**

Semiconductor Thermocouple (item 8.8)

**NOTES:**

- 1 — See Introduction for general information (note especially A3.1).
- 2 — Symbols for single-line (one-line) diagrams appear at the left, symbols for complete diagrams at the right, and symbols suitable for both purposes are centered in each column.
- 3 — For centered figures with symbols appearing side by side, the symbol on the left-hand side should be considered to be for a single line (one-line) diagram and the symbol on the right-hand side for a complete diagram, i.e., 1.5.1.

### 3. Graphic Symbols for Transmission Path

#### 3.1 Transmission Path

##### Conductor

##### Cable

##### Wiring

#### 3.1.1 Guided path, general

A single line represents the entire group of conductors or the transmission path needed to guide the power or signal. For coaxial and waveguide work, the recognition symbol is used at the beginning and end of each kind of transmission path and at intermediate points as needed for clarity. In waveguide work, mode may be indicated. IEC

When required, the length between two significant points may be indicated, e.g.,  $\lambda/4$ . IEC

When required, details of structure (e.g., elbow), type, impedance, ratings, etc, may be added adjacent to or within any symbol or in a note. IEC

See also item 3.2.1



#### 3.1.1.1 Bus bar (with connections shown)

Use only if essential to distinguish bus from other circuit paths.

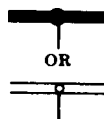

#### 3.1.2 Conductive path or conductor; wire



#### 3.1.2.1 Two conductors or conductive paths



#### 3.1.2.2 Three conductors or conductive paths



**3.1.2.3** “n” conductors or conductive paths

NOTE — 3.1.2.3A: The “n” is not part of the symbol. A number representing the actual number of paths shall be substituted for “n”.

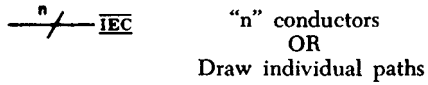

See Note 3.1.2.3A

**3.1.3** Air or space path

See also symbol 3.2.6

**3.1.4** Dielectric path other than air

Commonly used for coaxial and waveguide transmission.

**3.1.5** Crossing of paths or conductors not connected

The crossing is not necessarily at a 90-degree angle.

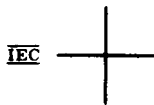
**3.1.6** Junction of paths or conductors**3.1.6.1** Junction (if desired)**3.1.6.2** Application: junction of paths, conductors, or cables. If desired, indicate path type, or size

### 3.1.6.3 Application: junction of connected paths, conductors, or wires

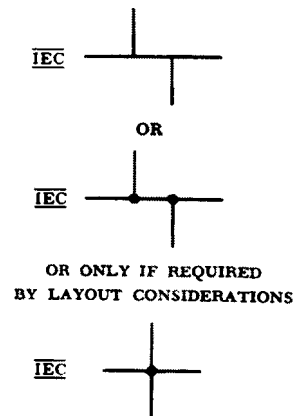

For microwave circuits, the type of coupling, power-division proportions, reflection coefficients, plane of junction, etc., may be indicated if desired.

### 3.1.6.4 Splice (if desired) of same size cables. Junction of conductors of same size or different size cables. If desired, indicate sizes of conductors



### 3.1.6.5 Conductor junction (such as hermaphroditic connectors)

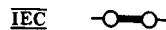

## 3.1.7 Associated conductors

### 3.1.7.1 General (shown with 3 conductors)



### 3.1.7.2 Twisted (shown with 2 twisted conductors)

NOTE — 3.1.7.2A: The asterisk is not part of the symbol. Always replace the asterisk by one of the following letters:

P = Pair  
T = Triple

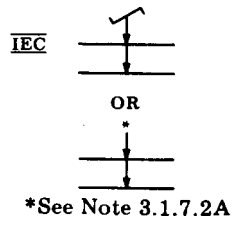

**3.1.7.3 Quad**

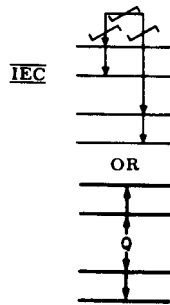

**3.1.7.4 Shielded (shown with 3 conductors out of 7 within shield)**

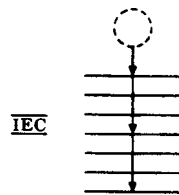

**3.1.8 Assembled conductors; cable**

Commonly used in communication diagrams.

**3.1.8.1 Shielded single conductor**

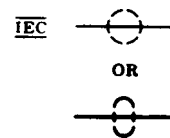

**3.1.8.2 Application: shielded 5-conductor cable**

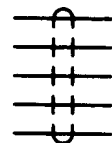

**3.1.8.3** Application: shielded 5-conductor cable with conductors separated on the diagram for convenience

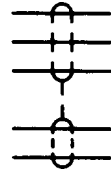

**3.1.8.4** Application: shielded 2-conductor cable with shield grounded

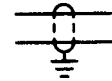

**3.1.8.5** 2-conductor cable

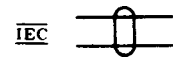

**3.1.8.6** Application: 5-conductor cable

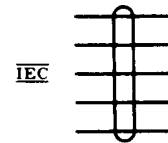

**3.1.9**<sup>5</sup> Coaxial cable, recognition symbol; coaxial transmission path; radio-frequency cable  (coaxial)

NOTES:

3.1.9A — If necessary for clarity, an outer-conductor connection shall be made to the symbol.

3.1.9B — If the coaxial structure is not maintained, the tangential line shall be drawn only on the coaxial side.

**3.1.9.1**<sup>5</sup> General

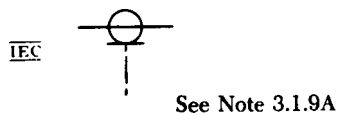

<sup>5</sup>The broken line - - - indicates where line connection to a symbol is made and is not part of the symbol.

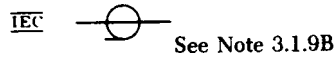
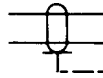
**3.1.9.2** Application: coaxial structure not maintained on the right**3.1.9.3**<sup>6</sup> Two conductors (balanced) with one outer-conductor connection (twinax)

See Note 3.1.9A

**3.1.9.4**<sup>6</sup> One conductor with one outer-conductor connection and one shielded connection (triax)

See Note 3.1.9A

**3.1.10** Grouping of leads**3.1.10.1** General

Bend of line indicates direction in which other ends of path will be found.

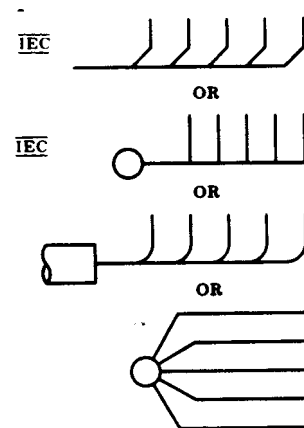
**3.1.10.2** Interrupted (on diagram), shown with individual paths at each side of diagrammatic interruption.

The lower symbol consists of long dashes.

<sup>6</sup>The broken line - - - indicates where line connection to a symbol is made and is not part of the symbol.



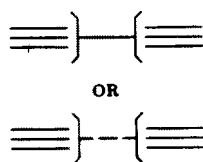

### 3.1.11 Interrupted path

Symbol normally used only when required for complex or special-purpose diagrams.

NOTES:

3.1.11A — To ensure continuity, the interrupted-path break points must be in alignment.

3.1.11B — The asterisk is not part of the symbol. Identifying values, letters, numbers, or marks shall replace the asterisk.

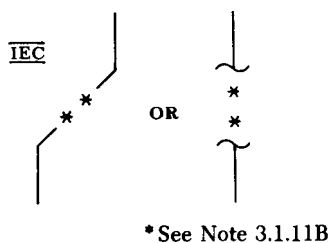

### 3.1.12 Conductor or cable end, not connected



#### 3.1.12.1 With end especially insulated



## 3.2 Distribution Lines Transmission Lines

Commonly used on system diagrams, maps, and charts.

### 3.2.1 Type of circuit

USE SYMBOL 3.1.1

The following letters may be used to indicate type of transmission:

F	telephony $\overline{\text{IEC}}$
S	sound (television) $\overline{\text{IEC}}$
T	telegraphy transmission of data $\overline{\text{IEC}}$
V	video (television) $\overline{\text{IEC}}$

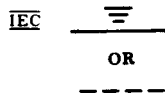
**3.2.1.1** Application: telephone line**3.2.2** Cable underground; underground line

These are long dashes.

Avoid conflict with symbol 3.2.6 if used on the same diagram.

**3.2.3** Submarine line; underwater line**3.2.4** Overhead line

Avoid conflict with symbol 3.6.1 if used on the same diagram.

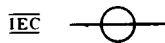
**3.2.5** Loaded line

Avoid conflict with symbol 6.4.18 if used on the same diagram.

**3.2.6** Radio link

Use only if essential to distinguish radio links or any radio portion of a circuit.

Avoid conflict with symbol 3.2.2 if used on the same diagram.

These are long dashes.



**3.2.6.1** Application: radio link (with antenna shown)

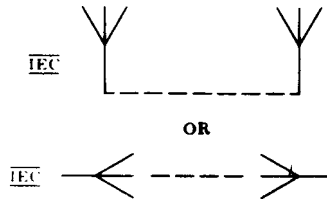

**3.2.6.2** Application: radio link carrying television (video with sound) and telephony (with antenna shown)

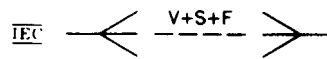

**3.3 Alternative or Conditional Wiring**

The arrowheads in this case shall be solid.

NOTE — 3.3A: A note shall explain the connections.



See Note 3.3A

**3.3.1** Application: 3 alternative paths

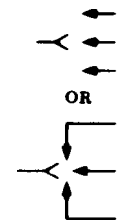

See Note 3.3A

**3.4 Associated or Future**

See also paragraph A4.10 of the Introduction

These are short dashes.



### 3.5 Intentional Isolation of Direct-Current Path in Coaxial or Waveguide Applications

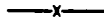

### 3.6 Waveguide

The mode of propagation or other special characteristics may be shown at the side of the waveguide symbol.

#### 3.6.1 Circular, recognition symbol

Avoid conflict with symbol 3.2.4 if used on the same diagram.

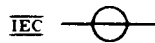

#### 3.6.2 Rectangular, recognition symbol

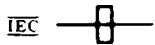

##### 3.6.2.1 Dielectric-filled metallic rectangular waveguide

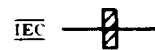

##### 3.6.2.2 Solid-dielectric rectangular waveguide

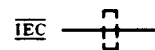

##### 3.6.2.3 Gas-filled rectangular waveguide



#### 3.6.3 Coaxial waveguide

See also item 3.1.9

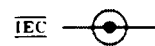

**3.6.4 Flexible waveguide**

Avoid conflict with symbol 2.12.3 if used on the same diagram.

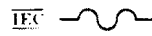
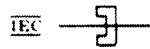
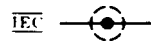
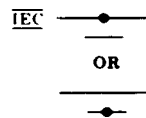
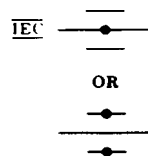
**3.6.5 Twisted waveguide****3.6.6 Ridged waveguide****3.6.7 Goubau line (single-wire transmission line within solid dielectric)****3.7 Strip-Type Transmission Line****3.7.1 Unbalanced stripline****3.7.2 Balanced stripline****3.8 Termination**

Commonly used on coaxial and waveguide diagrams.

**3.8.1 Open circuit (open). Not a fault.**

**3.8.2** Short circuit (short). Not a fault.

NOTE — 3.8.2A: Use of the dot is optional.

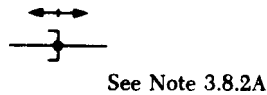
**3.8.3** Application: movable short circuit**3.9 Circuit Return****3.9.1** Ground, general symbol

NOTE — 3.9.1A: Supplementary information may be added to define the status or purpose of the earth if this is not readily apparent.

- 1) A direct conducting connection to the earth or body of water that is a part thereof.
- 2) A conducting connection to a structure that serves a function similar to that of an earth ground (that is, a structure such as a frame of an air, space, or land vehicle that is not conductively connected to earth).

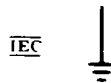
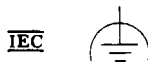
**3.9.1.1** Low-noise ground (IEC) noiseless, clean earth)**3.9.1.2** Safety or protective ground

NOTE — 3.9.1.2A: This symbol may be used in place of symbol 3.9.1 to indicate a ground connection having a specified protective function (e.g., for protection against electrical shock in case of a fault).

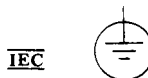
**3.9.2** Chassis or frame connection; equivalent chassis connection (of printed-wiring boards)

A conducting connection to a chassis or frame, or equivalent chassis connection of a printed-wiring board. The chassis or frame (or equivalent chassis connection of a printed-wiring board) may be at substantial potential with respect to the earth or structure in which this chassis or frame (or printed-wiring board) is mounted.

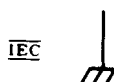

### 3.9.3 Common connections

Conducting connections made to one another.

All like-designated points are connected.

NOTE — 3.9.3A: The asterisk is not part of the symbol. Identifying values, letters, numbers, or marks shall replace the asterisk. For the triangular symbol, this identification shall be placed within the triangle or, if essential for legibility, adjacent to the triangle.

#### 3.9.3.1 Specific potential difference

To be used when there is a specific potential difference with respect to a potential reference level.

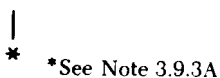

\* See Note 3.9.3A

#### 3.9.3.2 Potential level not specified by a numerical value

To be used when identically annotated common-return connections are at the same potential level.

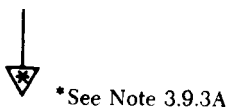

\* See Note 3.9.3A

## 3.10 Pressure Tight Bulkhead Cable Gland Cable Sealing End

NOTE — 3.10A: The high pressure side is to the right of the trapezoid, thus retaining gland.

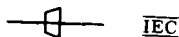

IEC

## Cross References

NOTES:

- 1 — See Introduction for general information (note especially A3.1).
- 2 — Symbols for single-line (one-line) diagrams appear at the left, symbols for complete diagrams at the right, and symbols suitable for both purposes are centered in each column.
- 3 — For centered figures with symbols appearing side by side, the symbol on the left-hand side should be considered to be for a single line (one-line) diagram and the symbol on the right-hand side for a complete diagram, i.e., 1.5.1.

## 4. Graphic Symbols for Contacts, Switches, Contactors, and Relays

### 4.1 Switching Function

NOTE — 4.1A: Switching function symbols are suitable for use on “detached contact” diagrams, but may be used in other applications.

#### 4.1.1 Conducting, closed contact (break)

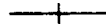

#### 4.1.2 Nonconducting, open contact (make)

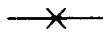

#### 4.1.3 Application: transfer

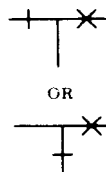

### 4.2 Electrical Contact E

For buildups or forms using electrical contacts, see applications under 5.3.5 and 5.3.6.

See paragraph A4.6 of the Introduction

#### 4.2.1 Fixed contact

##### 4.2.1.1 Fixed contact for jack, key, relay, switch, etc

See also symbol 4.2.1.2

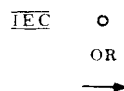

##### 4.2.1.2 Fixed contact with momentary contact (automatic return)

NOTE — 4.2.1.2A: When this symbol (representing a contact with automatic return) is used on a diagram for international use, the convention should be so noted on the diagram or associated documentation. IEC

See also 4.9 and 4.11

See also 4.9 and 4.11



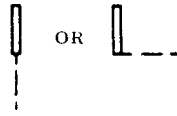

**4.2.1.3**<sup>7</sup> Sleeve**4.2.2** Moving Contact**4.2.2.1** Adjustable or sliding contact for resistor, inductor, etc**4.2.2.2** Locking**4.2.2.3** Nonlocking**4.2.2.4** Segment; bridging contact

See also items 4.13.3 and 4.13.4

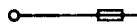
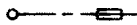
**4.2.2.5** Vibrator reed**4.2.2.6** Vibrator split reed**4.2.2.7** Rotating contact (slip ring) and brush

<sup>7</sup>The broken line - - - indicates where line connection to a symbol is made and is not part of the symbol.

### 4.3 Basic Contact Assemblies

The standard method of showing a contact is by a symbol indicating the circuit condition it produces when the actuating device is in the deenergized or nonoperated position. The actuating device may be of a mechanical, electrical, or other nature, and a clarifying note may be necessary with the symbol to explain the proper point at which the contact functions; for example, the point where a contact closes or opens as a function of changing pressure, level, flow, voltage, current, etc. In cases where it is desirable to show contacts in the energized or operated condition and where confusion may result, a clarifying note shall be added to the drawing.

Auxiliary switches or contacts for circuit breakers, etc, may be designated as follows:

- a) Closed when device is energized or operated position.
- b) Closed when device is in deenergized or nonoperated position.
  - aa) Closed when operating mechanism of main device is in energized or operated position.
  - bb) Closed when operated mechanism of main device is in deenergized or nonoperated position.

See American national Standard Manual and Automatic Station Control, Supervisory, and Associated Telemetering Equipment, C37.2-1970, for further details.

In the parallel-line contact symbols shown below, the length of the parallel lines shall be approximately  $1\frac{1}{4}$  times the width of the gap (except for symbol 4.3.7).

#### 4.3.1 Closed contact (break)

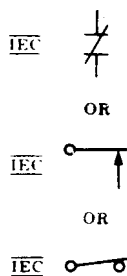

#### 4.3.2 Open contact (make)

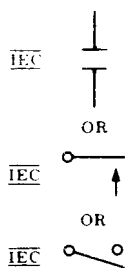

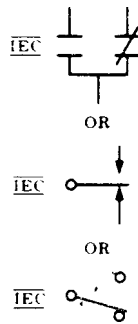
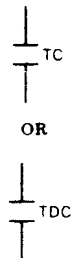
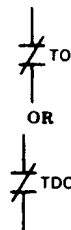
**4.3.3** Transfer**4.3.4** Make-before-break**4.3.5** Application: open contact with time closing (TC) or time-delay closing (TDC) feature**4.3.6** Application: closed contact with time opening (TO) or time-delay opening (TDO) feature

### 4.3.7 Time sequential closing

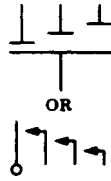

### 4.3.8 Multiway transfer switch

#### 4.3.8.1 Two-position switch (90° step)

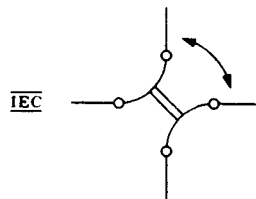

#### 4.3.8.2 Three-position switch (120° step)

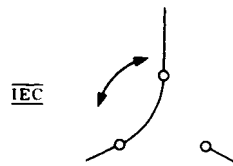

#### 4.3.8.3 Four-position switch (45° step)

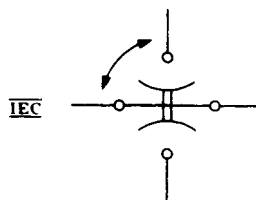

#### 4.4 <sup>8</sup> Magnetic Blowout Coil

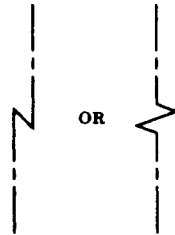

#### 4.5 Operating Coil Relay Coil

See also INDUCTOR; WINDING; etc (item 6.2)

NOTE — 4.5A: The asterisk is not part of the symbol. Always replace the asterisk by a device designation. See, for example, ANSI C37.2-1970.

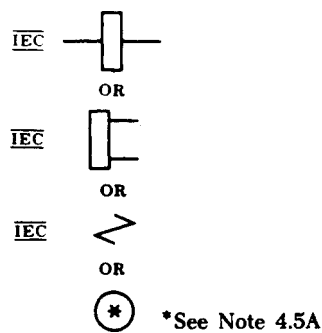

##### 4.5.1 Semicircular dot indicates inner end of winding

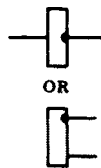

##### 4.5.2 Application: multiwinding coil (2 windings shown)

NOTE — 4.5.2A: The ends of a given winding shall be shown directly opposite each other on opposite sides of the core, or adjacent to each other on the same side of the core.

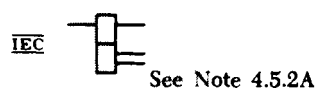

<sup>8</sup>The broken line - - - indicates where line connection to a symbol is made and is not part of the symbol.

### 4.5.3 Electromagnetic actuator $\overline{\text{IEC}}$ (solenoid), with mechanical linkage shown

NOTE — 4.5.3A: The mechanical linkage may be omitted if the intent is clear.

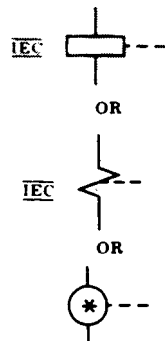

\* See Notes 4.5A and 4.5.3A

## 4.6 Switch

See also FUSE (item 9.1); and paragraphs A4.7 and A4.9 of the Introduction

Fundamentals symbols for contacts, mechanical connections, etc, may be used for switch symbols.

The standard method of showing switches is in a position with no operating force applied. For switches that may be in any of two or more positions with no operating force applied, and for switches actuated by some mechanical device (as in air-pressure, liquid-level, rate-of-flow, etc, switches), a clarifying note may be necessary to explain the point at which the switch functions.

When the basic switch symbols in items 4.6.1 through 4.6.3 are shown in the closed position on a diagram, terminals must be added for clarity.

### 4.6.1 Single-throw, general



### 4.6.2 Double-throw, general



#### 4.6.2.1 Application: 2-pole double-throw switch with terminals shown

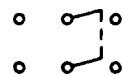

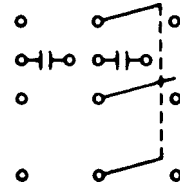

**4.6.3** Knife switch , general**4.6.4** Application: 3-pole double-throw knife switch with auxiliary contacts and terminals**4.6.5** Application: 2-pole field-discharge knife switch with terminals and discharge resistor

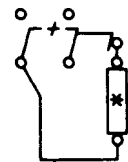
NOTE — 4.6.5A: The asterisk is not part of the symbol. Always add identification within or adjacent to the rectangle.

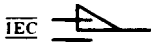

\*See Note 4.6.5A

**4.6.6** Switch with horn gap**4.6.7** Sector switch **4.7 Pushbutton , Momentary or Spring-Return****4.7.1** Circuit closing (make)

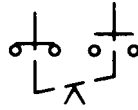
**4.7.2** Circuit opening (break)**4.7.3** Two-circuit**4.8** Two-circuit, Maintained or Not Spring-Return**4.9** Nonlocking Switch, Momentary or Spring-Return

The symbols to the left are commonly used for spring buildups in key switches, relays, and jacks.

The symbols to the right are commonly used for toggle switches.

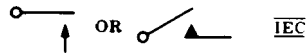
**4.9.1** Circuit closing (make)**4.9.2** Circuit opening (break)**4.9.3** Two-circuit

See Note 14.1.1A

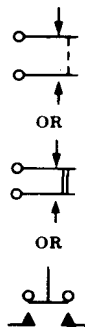

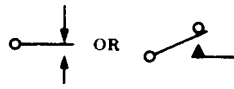
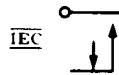

**4.9.4 Transfer****4.9.5 Make-before-break****4.10 Locking Switch**

The symbols to the left are commonly used for spring buildups in key switches and jacks.

The symbols to the right are commonly used for toggle switches.

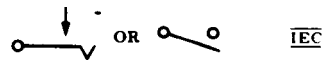
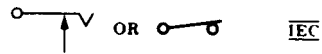
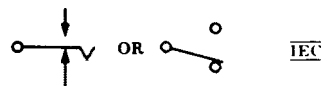
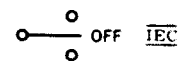
**4.10.1 Circuit closing (make)****4.10.2 Circuit opening (break)****4.10.3 Transfer, 2-position****4.10.4 Transfer, 3-position****4.10.5 Make-before-break**

## 4.11 Combination Locking and Nonlocking Switch

Commonly used for toggle switches

### 4.11.1 3-position, 1-pole: circuit closing (make), off, momentary circuit closing (make)

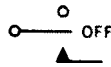

### 4.11.2 3-position, 2-pole: circuit closing (make), off, momentary circuit closing (make)

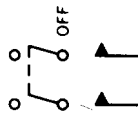

## 4.12 Key-Type Switch Lever Switch

### 4.12.1 2-position with locking transfer and break contacts

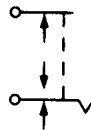

### 4.12.2 3-position with nonlocking transfer and locking break contacts

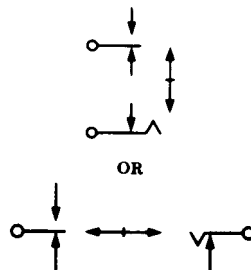

#### 4.12.3 3-position, multicontact combination

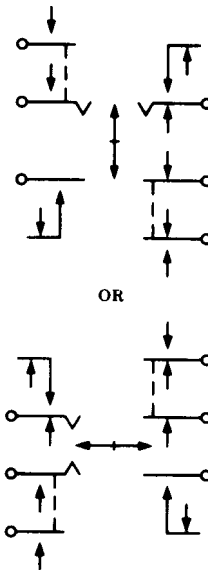

#### 4.12.4 2-position, half of key switch normally operated, multicontact combination

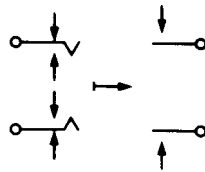



### 4.13 Selector or Multiposition Switch

The position in which the switch is shown may be indicated by a note or designation of switch position.

#### 4.13.1 General (for power and control diagrams)

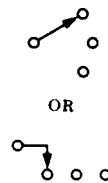
Any number of transmission paths may be shown.

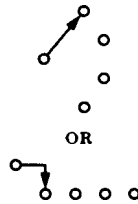
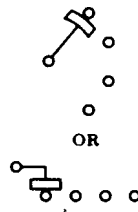
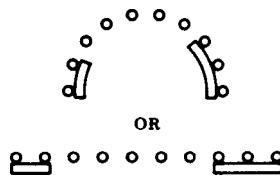
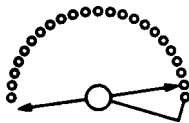
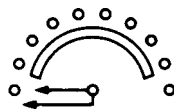

**4.13.2** Break-before-make, nonshorting (nonbridging) during contact transfer**4.13.3** Make-before-break, shorting (bridging) during contact transfer**4.13.4** Segmental contact**4.13.5** 22-point selector switch**4.13.6** 10-point selector switch with fixed segment**4.13.7** Rotary (section-, deck-, or wafer-type) 

Viewed from end opposite control knob or actuator unless otherwise indicated. For more than one section, the first section is the one nearest control knob or actuator. When contacts are on both sides, front contacts are nearest control knob.

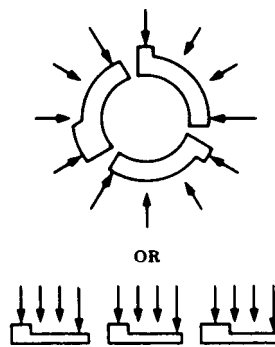

**4.13.8** Slide switch , typical ladder-type interlock

In the example, one slide is shown operated.

Slides are shown in released position unless otherwise noted.

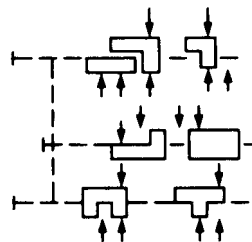

**4.13.9** Master or control switch

A table of contact operation must be shown on the diagram. A typical table is shown below.

**DETACHED CONTACTS SHOWN ELSEWHERE ON DIAGRAM**

CONTACT	INDICATOR POSITION		
	A	B	C
1-2			X
3-4	X		
5-6			X
7-8	X		
X-INDICATES CONTACTS CLOSED			

**4.13.10** Master or control switch (cam-operated contact assembly), 6-circuit 3-point reversing switch

A table of contact operation must be shown on the diagram. A typical table is shown below. Tabulate special features in note.

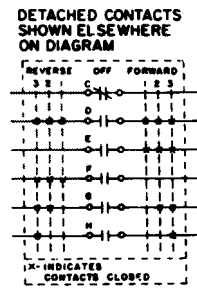

4.13.11 Drum switch, sliding-contact type, typical example

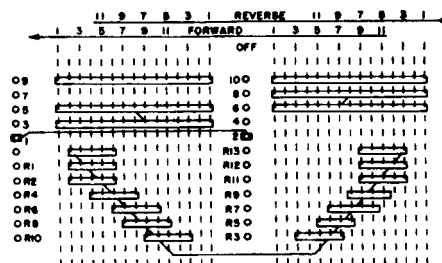

4.14 Limit Switch Sensitive Switch

NOTE — 4.14A: Identify by LS or other suitable note.

4.14.1 Track-type, circuit-closing contact



See Note 4.14A

4.14.2 Track-type, circuit-opening contact



See Note 4.14A

4.14.3 Lead-screw type, circuit-opening contacts

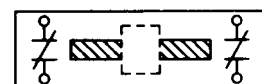

See Note 4.14A

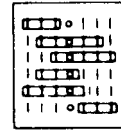
**4.14.4** Rotary-type

See Note 4.14A

**4.14.5** Limit switch, directly actuated, spring returned**4.14.5.1** Normally open**4.14.5.2** Normally open—held closed**4.14.5.3** Normally closed**4.14.5.4** Normally closed—held open**4.15 Safety Interlock**

If specific type identification is not required, use applicable standard symbol.

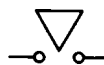
**4.15.1** If specific type identification is required: circuit opening**4.15.2** If specific type identification is required: circuit closing

## 4.16 Switches with Time-Delay Feature

NOTE — 4.16A: The point of the arrow indicates the direction of switch operation in which contact action is delayed.

### 4.16.1 Open switch with time-delay closing (TDC) feature

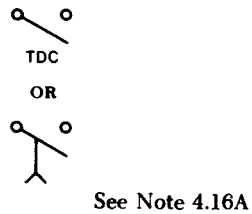

### 4.16.2 Closed switch with time-delay opening (TDO) feature

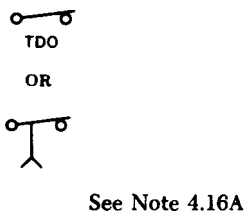

### 4.16.3 Open switch with time-delay opening (TDO) feature

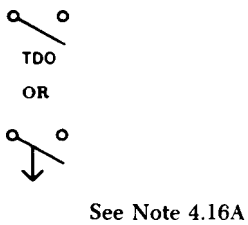

### 4.16.4 Closed switch with time-delay closing (TDC) feature

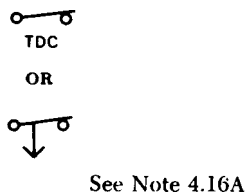



### 4.17 Flow-Actuated Switch

4.17.1 Closes on increase in flow.



4.17.2 Opens on increase in flow



### 4.18 Liquid-Level-Actuated Switch

4.18.1 Closes on rising level



4.18.2 Opens on rising level



### 4.19 Pressure- or Vacuum-Actuated Switch

4.19.1 Closes on rising pressure



4.19.2 Opens on rising pressure



## 4.20 Temperature-Actuated Switch

### 4.20.1 Closes on rising temperature

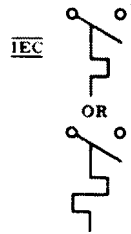

### 4.20.2 Opens on rising temperature

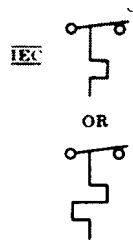

## 4.21 Thermostat

### NOTES:

4.21A — The  $t^\circ$  symbol shall be shown or be replaced by data giving the nominal or specific operating temperature of the device.

4.21B — If clarification of direction of contact operation is needed, a directional arrow may be added. The arrowhead shall point in the direction of rising temperature operation. A directional arrow shall always be shown for central-off (neutral) position devices.

### 4.21.1 Closes on rising temperature

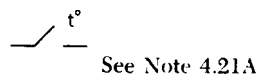

#### 4.21.1.1 With contact-motion direction clarified

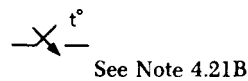

### 4.21.2 Opens on rising temperature

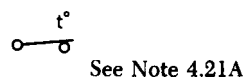

**4.21.3** Transfers on rising temperature

See Note 4.21A

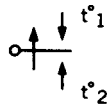
**4.21.4** Transfer, with intended central-off (neutral) position

See Notes 4.21A and B

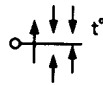
**4.21.5** Application: multifunction, typical

See notes 4.21A and B

**4.21.6** With integral heater and transfer contacts

Use only if essential to indicate integral heater details.

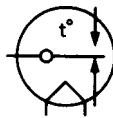

See Notes 4.21A and B

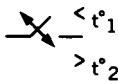
**4.21.7** Application: with operating temperatures indicated

See Notes 4.21A and B

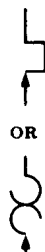
**4.22 Flasher  
Self-Interrupting Switch**

## 4.23 Foot-Operated Switch

### Foot Switch

#### 4.23.1 Opens by foot pressure



#### 4.23.2 Closes by foot pressure



## 4.24 Switch Operated by Shaft Rotation and Responsive to Speed or Direction

See also item 4.27

#### 4.24.1 Speed



#### 4.24.2 Plugging: to stop drive after it has come practically to rest



#### 4.24.3 Anti-plugging: to prevent plugging of drive



#### 4.24.4 Centrifugal switch (opening on increasing speed)

See also symbol 14.2.6



**4.25 Switches with Specific Features**

**4.25.1 Hook switch** 



**4.25.2 Telephone dial**  (switch)



**4.25.3 Switch in evacuated envelope, 1-pole double-throw**

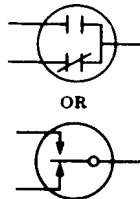

**4.25.4 Mushroom-head safety feature**

Application to 2-circuit pushbutton switch.





**4.25.5 Key-operated lock switch**

Use appropriate standard symbol and add key designation or other information in note.

**4.26 Telegraph Key** 

**4.26.1 Simple**

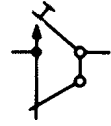
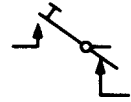

**4.26.2** Simple with shorting switch**4.26.3** Open-circuit or pole-changing**4.27 Governor**  **(Contact-making)**  
**Speed Regulator**

Contacts open or closed as required (shown here as closed).

**4.28 Vibrator, Interrupter** **4.28.1** Typical shunt drive (with terminals shown)

Show contacts as required.

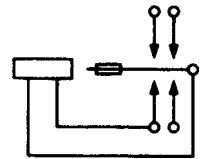
**4.28.2** Typical separate drive (with terminals shown)

Show contacts as required.

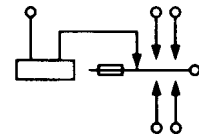
**4.29 Contactor**

See also CIRCUIT BREAKER (item 9.4)

Fundamental symbols for contacts, coils, mechanical connections, etc, are the basis of contactor symbols and should be used to represent contactors on complete diagrams. Complete diagrams of contactors consist of combinations of fundamental symbols for control coils, mechanical connections, etc, in such configurations as to represent the actual device. Mechanical interlocking should be indicated by notes.

**4.29.1** Manually operated 3-pole contactor

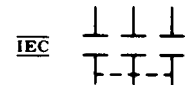

**4.29.2** Electrically operated 1-pole contactor with series blowout coil

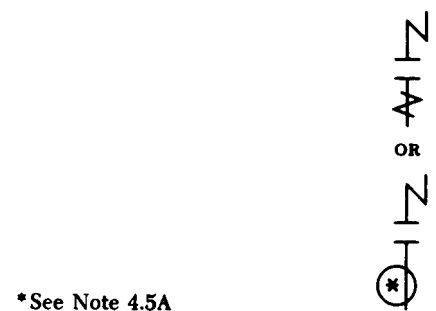

\* See Note 4.5A

**4.29.3** Electrically operated 3-pole contactor with series blowout coils; 2 open and 1 closed auxiliary contacts (shown smaller than the main contacts)

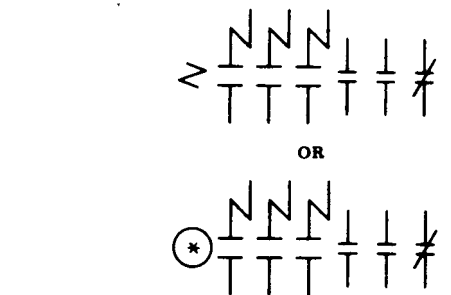

\* See Note 4.5A

**4.29.4** Electrically operated 1-pole contactor with shunt blowout coil

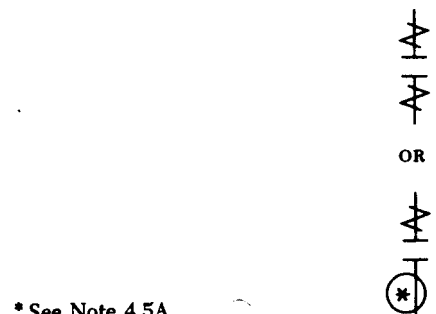

\* See Note 4.5A





### 4.30 Relay

See OPERATING COIL; RELAY COIL (item 4.5)

Fundamental symbols for contacts, mechanical connections, coils, etc, are the basis of relay symbols and should be used to represent relays on complete diagrams.

The following letter combinations or symbol elements may be used with relay symbols. The requisite number of these letters or symbol elements may be used to show what special features a relay possesses

The terms “slow” and “fast” are relative, and the degree is not to be noted by a multiplicity of the same relay symbol on a diagram. Relays that are direct-current operated are not marked to indicate dc operation.

	AC	Alternating-current or ringing relay
	D	Differential
	DB	Double-biased (biased in both directions)
	DP	Dashpot
	EP	Electrically polarized
	FO	Fast-operate
	FR	Fast-release
	L	Latching
	MG	Marginal
	ML	Magnetic-latching (remanent)
	NB	No bias
	NR	Nonreactive
	P	Magnetically polarized using biasing spring, or having magnet bias
	SA	Slow-operate and slow-release
	SO	Slow-operate
	SR	Slow-release
	SW	Sandwich-wound to improve balance to longitudinal currents

The proper poling for a polarized relay shall be shown by the use of + and - designations applied to the winding leads. The interpretation of this shall be that a voltage applied with the polarity as indicated shall cause the armature to move toward the contact shown nearer the coil on the diagram. If the relay is equipped with numbered terminals, the proper terminal numbers shall also be shown.

#### 4.30.1 Basic





**4.30.2** Application: relay with transfer contacts

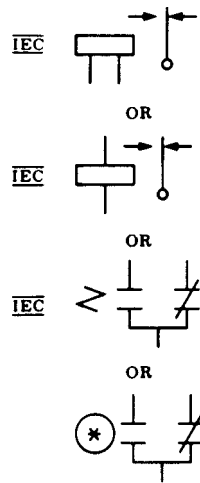

\* See Note 4.5A

**4.30.3** Application: polarized relay with transfer contacts (two typical types shown)

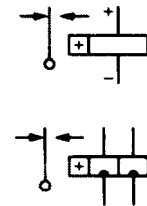

**4.30.4** Application: polarized (no bias) marginal relay with transfer contacts

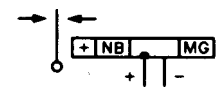

**4.30.5** Relay, thermally operated

**4.30.5.1** Activating device for thermally operated relay

Time of delay may be shown.

Contacts may be shown separately from the operating device.

See also item 2.14

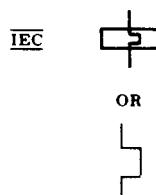

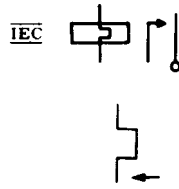
**4.30.5.2** With normally open contacts shown (two typical types)**4.30.5.3** With transfer contacts shown**4.30.6** Thermal relay, one-time type, not reusable

Normally open contact type shown.

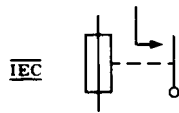
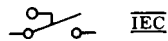
**4.31 Inertia Switch (operated by sudden deceleration)**

NOTE — 4.31A: This symbol is commonly used on diagrams for aerospace applications.

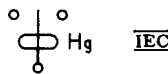
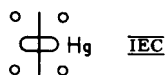
**4.32 Mercury Switch****4.32.1** Leveling**4.32.1.1** Three terminal**4.32.1.2** Four terminal

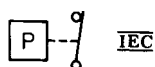
**4.32.2** With acceleration cutoff (four terminal)**4.33** Aneroid Capsule (air pressure) Operated Switch**Cross References**

Protective Relay (item 9.5)

**NOTES:**

- 1 — See Introduction for general information (note especially A3.1).
- 2 — Symbols for single-line (one-line) diagrams appear at the left, symbols for complete diagrams at the right, and symbols suitable for both purposes are centered in each column.
- 3 — For centered figures with symbols appearing side by side, the symbol on the left-hand side should be considered to be for a single line (one-line) diagram and the symbol on the right-hand side for a complete diagram, i.e., 1.5.1.

**5. Graphic Symbols for Terminals and Connectors****5.1 Terminals****5.1.1** Circuit terminal**5.1.1.1** Terminal board  or terminal strip, with 4 terminals shown; group of 4 terminals

Number and arrangement as convenient.

NOTE — 5.1.1.1A: Internal lines and terminals may be omitted if terminal identifications are shown within the symbol.

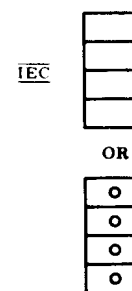

See Note 5.1.1.1A

### 5.1.2 Terminals for electron tubes, semiconductor devices, etc

Used primarily in application-data terminal diagrams for electron tubes, semiconductor devices, and other devices having terminations of similar type.

#### NOTES:

5.1.2A — Explanatory words and arrows are not part of the symbol.

5.1.2B — The following letter combinations, if shown adjacent to terminal symbols requiring special attention, shall signify the following:

- S Connection to an external shield integral with a device (including metal tube shell, base sleeve or shell; external conductive coating or casing). Not to be used if the external conductive coating serves as one side of a capacitor (as in cathode-ray tubes) and is not designed to function as an electrostatic shield.
- IC Internal connection: not intended to be used for circuit connection.
- IS Internal shield not depicted in terminal diagram.

#### 5.1.2.1 Base-pin terminals (electron tubes, etc); pin terminals (semiconductor devices, etc)

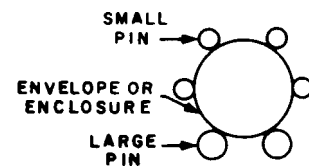

See Note 5.1.2A

#### 5.1.2.2 Envelope terminals

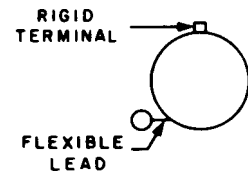

See Note 5.1.2A

The rigid-terminal symbol is used to indicate customary rigid terminals (caps, rods, rings, etc) as well as to indicate:

- 1) Any metallic envelope or external conductive coating or casing that has a contact area (as in cathode-ray tubes, disc-seal tubes, pencil tubes, etc).
- 2) Mounting flange or stud when it serves as a terminal.

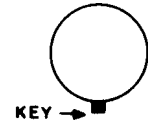
**5.1.2.3** Device with base-orientation key

See Note 5.1.2A

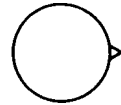
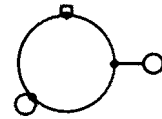
**5.1.2.4** Devices with reference point (such as a boss, colored dot, index pin, index tab, or bayonet pin)**5.1.2.5** Terminals connected to metallic envelope or enclosure**5.2 Cable Termination**

Line shown on left of symbol indicates cable.

**5.3 Connector  
Disconnecting Device**

**Jack** 

**Plug** 

The contact symbol is not an arrowhead. It is larger and the lines are drawn at a 90-degree angle.

**5.3.1** Female contact**5.3.2** Male contact

**5.3.3** Connector assembly, movable or stationary portion; jack, plug, or receptacle

NOTE — 5.3.3A: Use appropriate number of contact symbols.

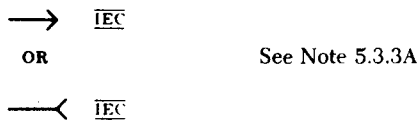

**5.3.3.1** Receptacle or jack (usually stationary)

NOTE — 5.3.3.1A: The asterisk is not part of the symbol. If desired, indicate the type of contacts: male (→) or female (⤵).

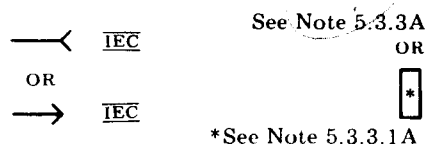

**5.3.3.2** Plug (usually movable)

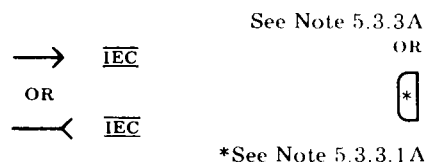

**5.3.4** Separable connectors (engaged)

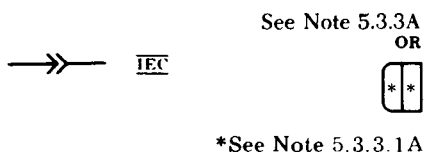

**5.3.4.1** Application: engaged 4-conductors (female plug male receptacle shown)

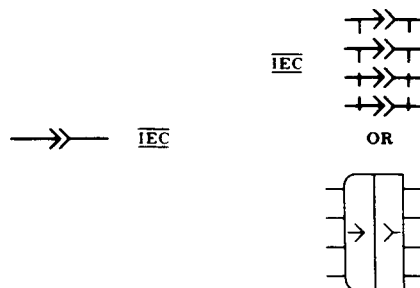

**5.3.4.2** Application: engaged 4-conductor connectors; the plug has 1 male and 3 female contacts with individual contact designations shown in the complete-symbol column

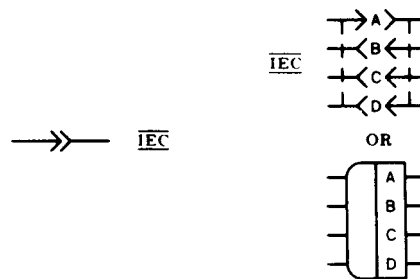

### 5.3.5 Communication switchboard-type connector

See also symbol 4.2.1.4

#### 5.3.5.1 2-conductor (jack)



#### 5.3.5.2 2-conductor (plug)



#### 5.3.5.3<sup>9</sup> 3-conductor (jack) with 2 break contacts (normals) and 1 auxiliary make contact

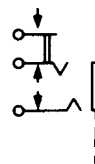

#### 5.3.5.4 3-conductor (plug)



**5.3.6** Communication switchboard-type connector with circuit normalled through “Normalled” indicates that a through circuit may be interrupted by an inserted connector. As shown here, the inserted connector opens the through circuit and connects to the circuit towards the left.

Items 5.3.6.1 through 5.3.6.4 show 2-conductor jacks. The “normal” symbol is applicable to other types of connectors.

See also symbol 4.2.1.3

<sup>9</sup>The broken line - - - indicates where line connection to a symbol is made and is not part of the symbol.

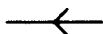

### 5.3.6.1 Jacks with circuit normalled through one way



### 5.3.6.2 Jacks with circuit normalled through both ways

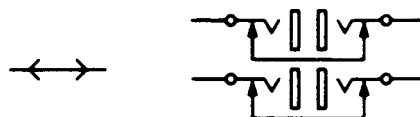

### 5.3.6.3 Jacks in multiple, one set with circuit normalled through both ways

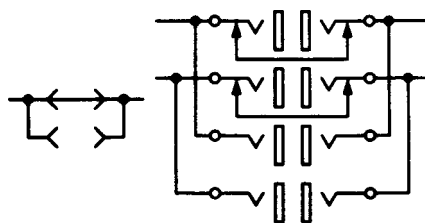

### 5.3.6.4 Jacks with auxiliary contacts, with circuit normalled through both ways

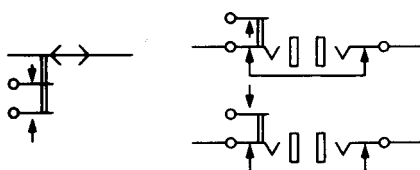

## 5.4 Connectors of the Type Commonly Used for Power-Supply Purposes (convenience outlets and mating connectors). American National Standard Dimensions of Attachment Plugs and Receptacles. C73.10-1966 (R1972) through C73.68-1966 (R1972).

See also symbols 5.3.3.1 and 5.3.3.2

The following symbols are primarily for applications where the type of connector must be indicated semipictorially.

Contacts and contact arrangements shall be shown in simplified form as viewed from the mating face, approximately in proportion to the arrangement in the physical item. A simplified-shape outline shall surround the contact symbols.

### 5.4.1 Male contact

Filled outline, approximating contact end-view (3 typical forms are shown)





#### 5.4.2 Female contact

Open outline, approximating limiting shape of mating male contact (3 typical forms are shown)



#### 5.4.3 Application: 2-conductor nonpolarized connector with male contacts (3 typical forms are shown)

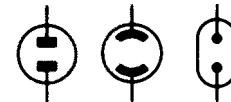

#### 5.4.4 Application: 2-conductor nonpolarized connector with female contacts (3 typical forms are shown)

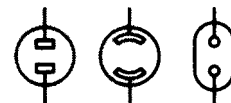

#### 5.4.5 Application: 2-conductor polarized connector (2 typical forms with female contacts are shown)

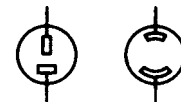

#### 5.4.6 Application: 3-conductor polarized connector (5 typical forms with female contacts are shown)

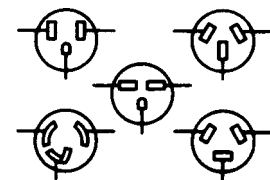

#### 5.4.7 Application: 4-conductor polarized connector (2 typical forms with female contacts are shown)

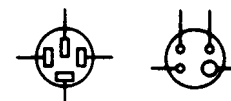

## 5.5 Test Block

### 5.5.1 Female portion with short-circuiting bar (with terminals shown)



### 5.5.2 Male portion (with terminals shown)



## 5.6 Coaxial Connector Coaxial Junction

### 5.6.1 Engaged coaxial connectors

Coaxial recognition symbol may be added if necessary. See COAXIAL TRANSMISSION PATH (item 3.1.9)

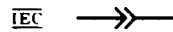

### 5.6.2 Application: coaxial with the outside conductor shown carried through



### 5.6.3 Application: coaxial with center conductor shown carried through; with outside conductor terminated on chassis

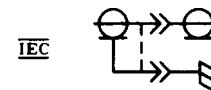

### 5.6.4 Application: coaxial with center conductor shown carried through; outside conductor not carried through

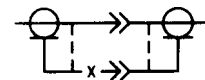

### 5.6.5 Application: T or Y adapter with outer conductor carried through

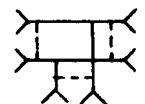

## 5.7 Waveguide Flanges

### Waveguide Junction

#### 5.7.1 Mated pair of symmetrical waveguide connectors

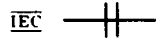

#### 5.7.2 Mated pair of asymmetrical waveguide connectors

The line is not interrupted at the junction whether or not it is a plain-type or choke-type connection.

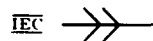

#### 5.7.3 Plain (rectangular waveguide)

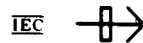

#### 5.7.4 Choke (rectangular waveguide)



#### 5.7.5 Application: rectangular waveguide with mated plain and choke flanges with direct-current isolation (insulation) between sections of waveguide

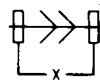

## Cross References

### NOTES:

- 1 — See Introduction for general information (note especially A3.1).
- 2 — Symbols for single-line (one-line) diagrams appear at the left, symbols for complete diagrams at the right, and symbols suitable for both purposes are centered in each column.
- 3 — For centered figures with symbols appearing side by side, the symbol on the left-hand side should be considered to be for a single line (one-line) diagram and the symbol on the right-hand side for a complete diagram, i.e., 1.5.1.

## 6. Graphic Symbols for Transformers, Inductors, and Windings

### 6.1 Core

#### 6.1.1 General or air core

If it is necessary to identify an air core, a note should appear adjacent to the symbol of the inductor or transformer

NO SYMBOL

#### 6.1.2 Magnetic core of inductor or transformer

Not to be used unless it is necessary to identify a magnetic core.



#### 6.1.3 Core of magnet

For use if representation of the core is necessary. See PERMANENT MAGNET (item 2.8)



#### 6.1.4 Magnetic-memory core

Commonly used in magnetic-memory and magnetic channel-selector devices.

See also item 15.18.

##### 6.1.4.1 Single-aperture type with windings shown



**6.1.4.2 Application:** in an array having four windings—two WRITE-READ windings, one INHIBIT winding, and one SENSE winding

NOTE — 6.1.4.2A: Words are for explanation and are not part of the symbol.

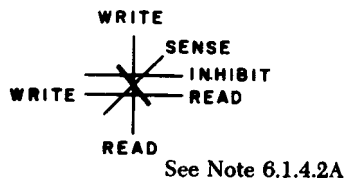

**6.2 Inductor****Winding (machine or transformer)****Reactor Radio-Frequency Coil****Telephone Retardation Coil**

See also OPERATING COIL (item 4.5) For polarity markings see item 1.6.3

**6.2.1 General**

NOTE — 6.2.1A: This symbol is deprecated and should not be used on new schematics.

**6.2.2 Magnetic-core inductor****Telephone loading coil**

If necessary to show a magnetic core.

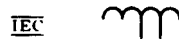
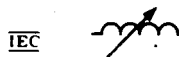
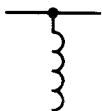
**6.2.3 Tapped****6.2.4 Adjustable inductor****6.2.5 Adjustable or continuously adjustable inductor****6.2.6 Shunt inductor****6.2.7 Inductive termination**

Commonly used in coaxial and waveguide diagrams.

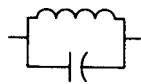
**6.2.7.1** Application: series inductor and path open**6.2.7.2** Application: series inductor and path short-circuited**6.2.8** Carrier line trap (carrier elimination filter)**6.2.8.1** General

NOTE — 6.2.8.1A: If it is essential to indicate the following characteristics, the specified letter or letters may be inserted within or placed adjacent to the symbol.

2f	Two frequency
WB	Wide band
NB	Narrow band

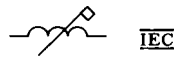
**6.2.9** Coil operated flag indicator

## 6.3 Transductor

### Saturable-Core Inductor

### Saturable-Core Reactor

## NOTES:

6.3A — If essential for clarity, the magnetic core symbol, 6.1.2, may be added where applicable.

6.3B — Power windings are drawn with three scallops or loops, control windings with five.

6.3C — The saturable-properties indicator, symbol 1.2.4, may also be used to indicate two or more windings.

**6.3.1** Transductor element, assembled

When windings are separated on a drawing, suitable indication shall be provided to show that they are on the same core.

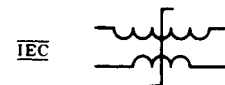

**6.3.2** Application: single-phase series transductor with winding-polarity and kind-of-current markings shown

NOTE — 6.3.2A: An increase of current entering the end of the control winding marked with a dot causes an increase in the power output.

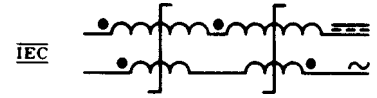

See Notes 6.3B and C

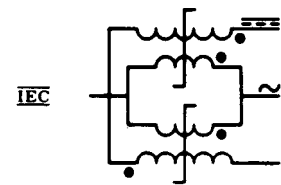
**6.3.3** Application: single-phase parallel transductor with winding-polarity and kind-of-current markings shown

See Notes 6.3B, 6.3C, and 6.3.2A

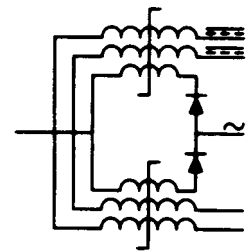
**6.3.4** Application: self-exciting transductor with two control circuits and kind-of-current markings shown

See Note 6.3B

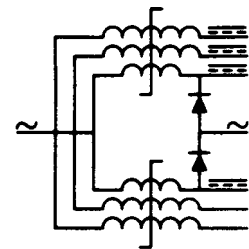
**6.3.5** Application: transductor with direct-current output and kind-of-current markings shown

See Note 6.3B

## 6.4 Transformer

### Telephone Induction Coil

### Telephone Repeating Coil

#### 6.4.1 General

Additional windings may be shown or indicated by a note.

For polarity markings on current and potential transformers, see symbol 1.6.3.

In coaxial and waveguide circuits, this symbol represents a taper or step transformer without mode change.

NOTE — 6.4.1A: This symbol is the preferred symbol from IEC Publication 117, Recommended Graphical Symbols. It should be used on schematics for equipments having international usage, especially when the equipment will be marked using this symbol (in accordance with IEC Publication 417, Graphical Symbols for Use on Equipment).

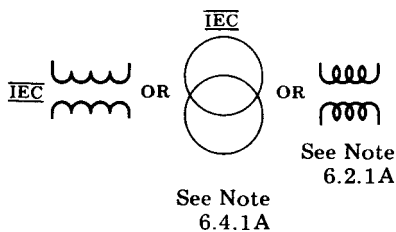

**6.4.1.1** Application: transformer with direct-current connections and mode suppression between two rectangular waveguides

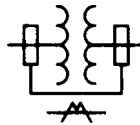

#### 6.4.2 Magnetic-core transformer

If necessary to show a magnetic core.

##### 6.4.2.1 Nonsaturating



**6.4.2.2** Application: shielded transformer with magnetic core shown





**6.4.2.3** Application: transformer with magnetic core shown and with an electrostatic shield between windings. The shield is shown connected to the frame.



### 6.4.3 Saturating transformer

See SATURABLE-PROPERTIES INDICATOR (symbol 1.2.4)

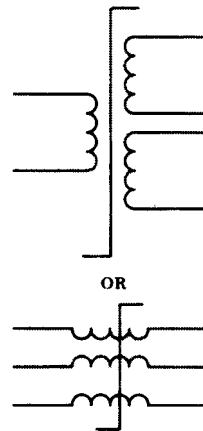

### 6.4.4 One winding with adjustable inductance

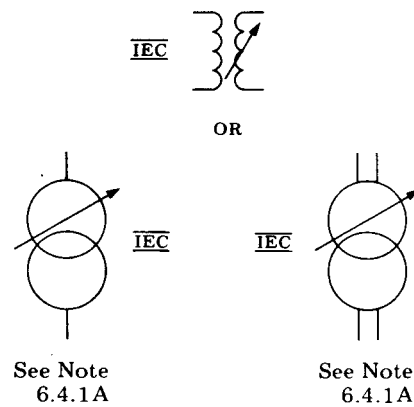

### 6.4.5 Each winding with separately adjustable inductance

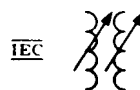

**6.4.6** Adjustable mutual inductor; constant-current transformer



**6.4.7** With taps, 1-phase



**6.4.8** Autotransformer, 1-phase

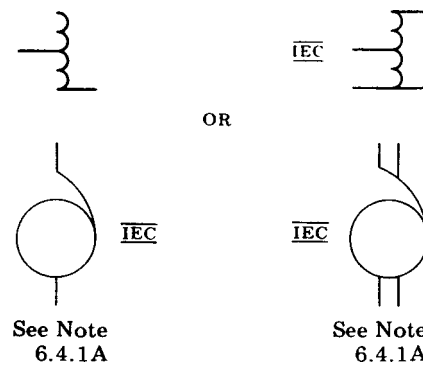

**6.4.9** Adjustable

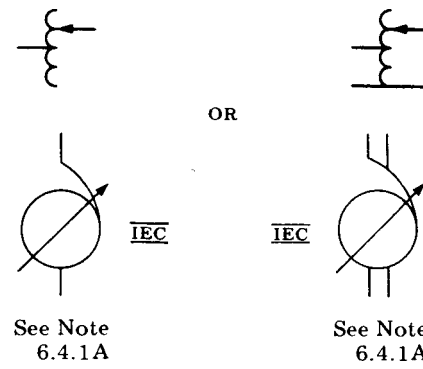

**6.4.10** Step-voltage regulator or load-ratio control autotransformer



**6.4.10.1** Step-voltage regulator



**6.4.10.2** Load-ratio control auto-transformer



**6.4.11** Load-ratio control transformer with taps



**6.4.12** 1-phase induction voltage regulator(s)

Number of regulators may be written adjacent to the symbol.



OR

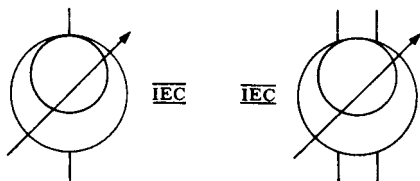

See Note  
6.4.1A

See Note  
6.4.1A

**6.4.13** Triplex induction voltage regulator



**6.4.14** 3-phase induction voltage regulator

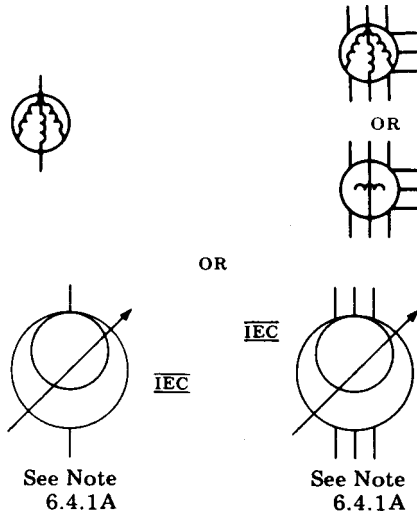

**6.4.15** 1-phase, 2-winding transformer

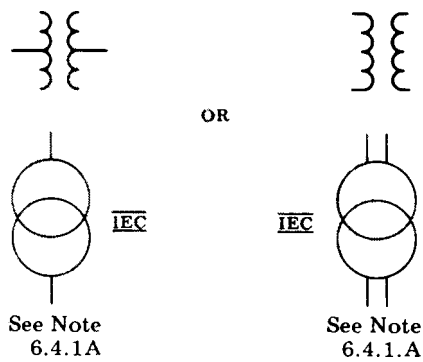

**6.4.15.1** Application: 3-phase bank of 1-phase, 2-winding transformers with wye-delta connections

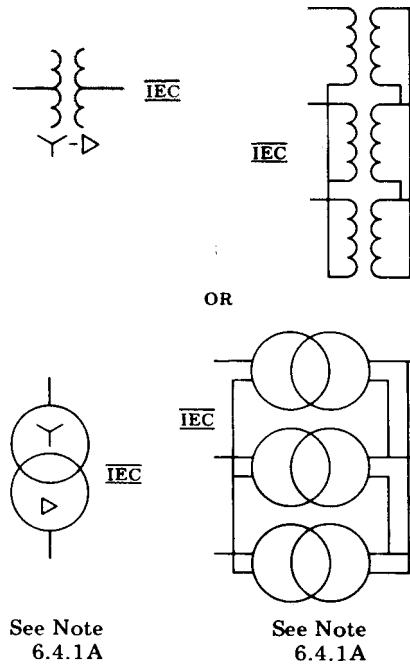

**6.4.15.2** Three phase transformer with 4 taps with wye-wye connections

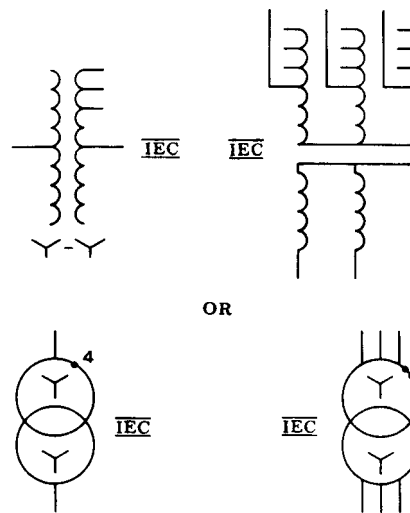

**6.4.16** Polyphase transformer

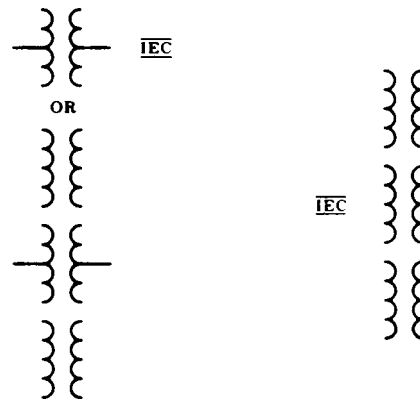

**6.4.17** 1-phase, 3-winding transformer

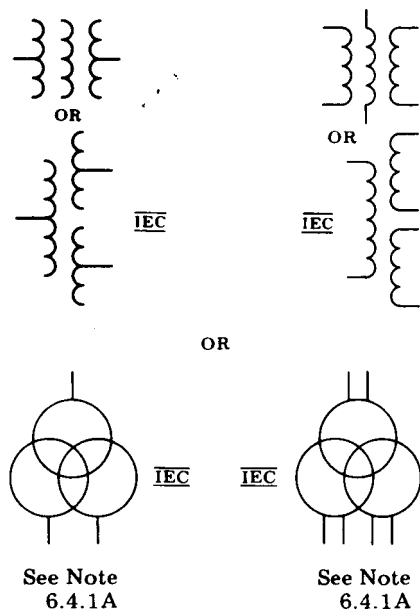

**6.4.18** Current transformer(s)

Avoid conflict with symbol 3.2.5 if used on the same diagram.

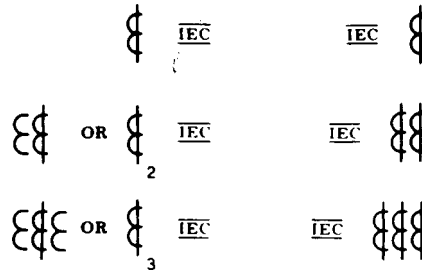

**6.4.19**<sup>10</sup> Bushing-type current transformer



**6.4.20** Potential transformer(s)

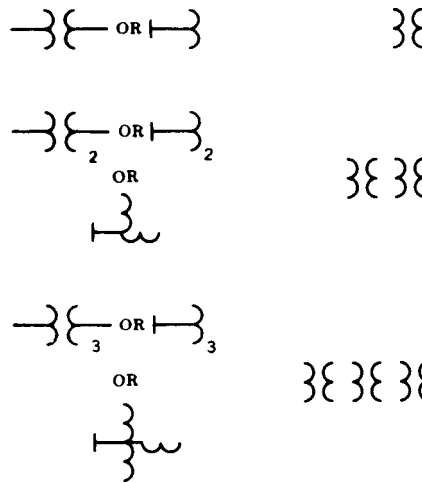

**6.4.21** Outdoor metering device



SHOW ACTUAL  
CONNECTION  
INSIDE BORDER

<sup>10</sup>The broken line - - - indicates where line connection to a symbol is made and is not part of the symbol.

## 6.5<sup>11</sup> Linear Coupler



### Cross References

#### NOTES:

- 1 — See Introduction for general information (note especially A3.1).
- 2 — Symbols for single-line (one-line) diagrams appear at the left, symbols for complete diagrams at the right, and symbols suitable for both purposes are centered in each column.
- 3 — For centered figures with symbols appearing side by side, the symbol on the left-hand side should be considered to be for a single line (one-line) diagram and the symbol on the right-hand side for a complete diagram, i.e., 1.5.1.

## 7. Graphic Symbols for Electron Tubes and Related Devices

### 7.1 Electron Tube E

See also ENVELOPE; ENCLOSURE (item 1.10) and TERMINALS FOR ELECTRON TUBES, SEMICONDUCTOR DEVICES, ETC (item 5.1.2)

Tube-component symbols are shown first. These are followed by typical applications showing the use of these specific symbols in the various classes of devices such as thermionic, cold-cathode, and photoemissive tubes of varying structures and combinations of elements (triodes, cathode-ray tubes, etc).

Lines outside of the envelope are not part of the symbol but are electrical connections thereto.

Connections between the external circuit and electron-tube symbols within the envelope may be located as required to simplify the diagram.

#### 7.1.1 Emitting electrode

##### 7.1.1.1 Directly heated (filamentary) cathode

NOTE — 7.1.1.1A: Leads may be connected in any convenient manner to ends of the  $\wedge$  provided the identity of the  $\wedge$  is retained.



##### 7.1.1.2 Indirectly heated E cathode

Lead may be connected to either extreme end of the  or, if required, to both ends, in any convenient manner.

<sup>11</sup>The broken line - - - indicates where line connection to a symbol is made and is not part of the symbol.





### 7.1.1.3 Cold cathode (including ionically heated cathode)



### 7.1.1.4 Photocathode



### 7.1.1.5 Pool cathode

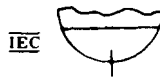

### 7.1.1.6 Ionically heated cathode with provision for supplementary heating

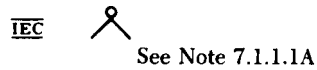

## 7.1.2 Controlling electrode

### 7.1.2.1 Grid (including beam-confining or beam-forming electrodes)

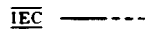

### 7.1.2.2 Deflecting electrodes (used in pairs); reflecting or repelling electrode (used in velocity-modulated tubes)

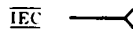

### 7.1.2.3 Ignitor (in pool tubes) (should extend into pool); starter (in gas tubes)



### 7.1.2.4 Excitor (contactor type)

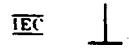

**7.1.3** Collecting electrode**7.1.3.1** Anode or plate**7.1.3.2** Target or x-ray anode

Drawn at about a 45-degree angle.

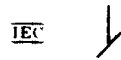
**7.1.3.3** Fluorescent target

Drawn at about a 45-degree angle.

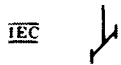
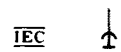
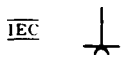
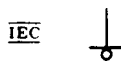
**7.1.3.4** Collector**7.1.4** Collecting and emitting electrode**7.1.4.1** Dynode**7.1.4.2** Alternately collecting and emitting electrode**7.1.4.2.1** Composite anode-photocathode**7.1.4.2.2** Composite anode-cold cathode

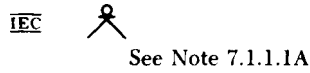
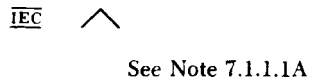
**7.1.4.2.3** Composite anode-ionically heated cathode with provision for supplementary heating**7.1.5** Heater**7.1.6** Shield

See symbol 7.2.10

This is understood to shield against electric fields unless otherwise noted.

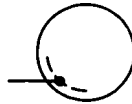
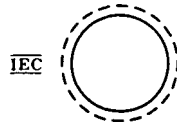
**7.1.6.1** Any shield against electric fields that is within the envelope and that is connected to an independent terminal**7.1.6.2** Outside envelope of x-ray tube**7.1.7** Coupling

See COUPLING (item 15.2), COAXIAL TRANSMISSION PATH (item 3.1.9), and WAVEGUIDE (item 3.6)

**7.1.7.1** Coupling by loop (electromagnetic type)

Coupling loop may be shown inside or outside envelope as desired.

**7.1.8**<sup>12</sup> Ion-diffusion barrier, shown with envelope

Commonly used with liquid-filled tubes.

<sup>12</sup>The broken line - - - indicates where line connection to a symbol is made and is not part of the symbol.

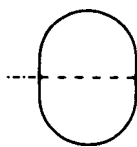

## 7.2 General Notes

**7.2.1** If new symbols are necessary, they should be formed where possible from component symbols. For example, see DYNODE (item 7.1.4.1), which combines the anode and photocathode conventions.

**7.2.2** A connection to anode, dynode, pool cathode, photocathode, deflecting electrode, composite anode-photocathode, and composite anode-cold cathode shall be to the center of that symbol. Connection to any other electrode may be shown at either end or both ends of the electrode symbol.

**7.2.3** A diagram for a tube having more than one heater or filament shall show only one heater or filament symbol  $\wedge$  unless they have entirely separate connections. If a heater or filament tap is made, either brought out to a terminal or internally connected to another element, it shall be connected at the vertex of the symbol, regardless of the actual division of voltage across the heater or filament.

**7.2.4** Standard symbols, such as the inclined arrow for tunability and connecting dotted lines for ganged components, may be added to a tube symbol to extend the meaning of the tube symbol, provided such added feature or component is integral with the tube.

**7.2.5** Electric components, such as resistors, capacitors, or inductors, which are integral parts of the tube and are important to its functional operation, shall be shown in the standard manner.

**7.2.6** Multiple equipotential cathodes that are directly connected inside the tube shall be shown as a single cathode.

**7.2.7** A tube having two or more grids tied internally shall be shown with symbols for each grid, except when the grids are adjacent in the tube structure. Thus, the diagram for a twin pentode having a common screen-grid connection for each section and for a converter tube having the No. 3 and No. 5 grids connected internally would show separate symbols for each grid. A triode where the control grid is physically in the form of two grid windings, however, would show only one grid.

**7.2.8** A tube having a grid adjacent to a plate but internally connected to the plate to form a portion of it shall be shown as having a plate only.

**7.2.9** Associated parts of a circuit, such as focusing coils, deflecting coils, field coils, etc, are not part of the tube symbol but may be added to the circuit in the form of standard symbols. For example, a resonant-type magnetron with permanent magnet may be shown as follows (see symbol 15.11.1):

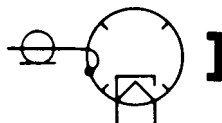

**7.2.10** External and internal shields, whether integral parts of tubes or not, shall be omitted from the circuit diagram unless the circuit diagram requires their inclusion.

**7.2.11** In line with standard drafting practice, straight-line crossovers are recommended.

### 7.3 Typical Applications

**7.3.1** Triode with directly heated filamentary cathode and envelope connection to base terminal

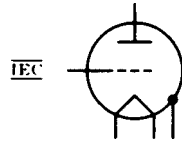

**7.3.2** Equipotential-cathode pentode showing use of elongated envelope

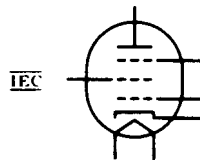

**7.3.3** Equipotential-cathode twin triode showing use of elongated envelope and rule of item 7.2.3.

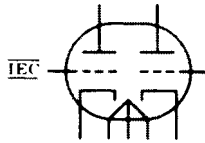

**7.3.4** Cold-cathode gas-filled tube

**7.3.4.1** Rectifier; voltage regulator for direct-current operation

See also symbol 11.1.3.2

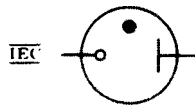

**7.3.5** Phototube

**7.3.5.1** Single-unit, vacuum-type

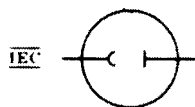

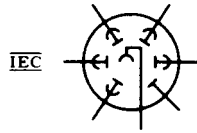
**7.3.5.2 Multiplier-type****7.3.6 Cathode-ray tube**

See Note 1.10A

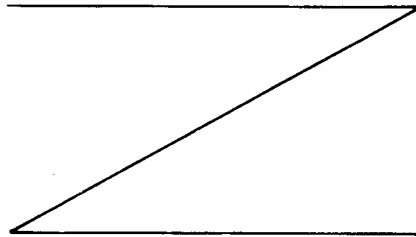
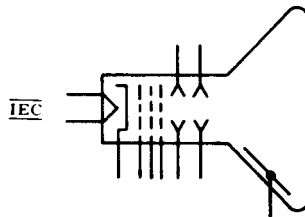
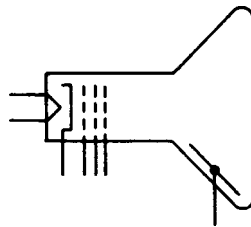
**7.3.6.1 With electric-field (electrostatic) deflection****7.3.6.2 For electromagnetic deflection****7.3.6.2.1 Single-gun**

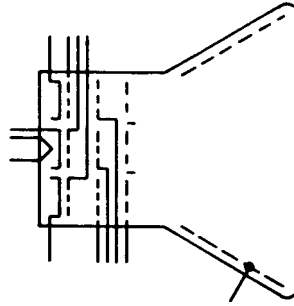
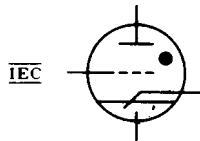
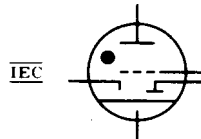
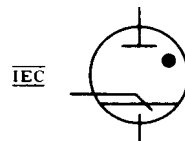
**7.3.6.2.2** Multiple-gun (three-gun shown)**7.3.7** Mercury-pool tube**7.3.7.1** With ignitor and control grid**7.3.7.2** With excitor, control grid, and holding anode**7.3.7.3** Single-anode pool-type vapor rectifier with ignitor**7.3.7.4** 6-anode metallic-tank pool-type vapor rectifier with excitor, showing rigid-terminal symbol for control connection to tank (pool cathode is insulated from tank)

Anode symbols are located as convenient.

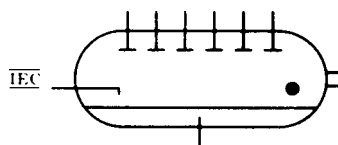

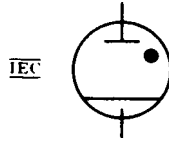
**7.3.7.5** Pool-type cathode power rectifier**7.3.8** X-ray tube**7.3.8.1** With filamentary cathode and focusing grid (cup)

The anode may be cooled by fluid or radiation.

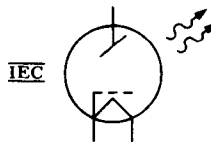
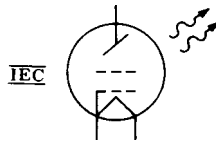
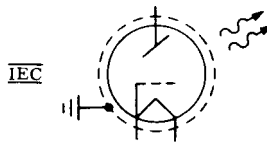
**7.3.8.2** With control grid, filamentary cathode, and focusing cup**7.3.8.3** With grounded electrostatic shield**7.3.8.4** Double focus with rotating anode

See item 7.2.9

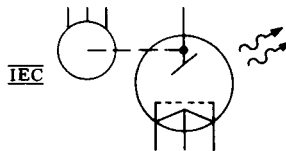
**7.3.8.5** With multiple accelerating electrode electrostatically and electromagnetically focused

See item 7.2.9



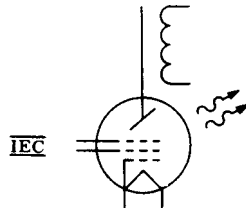

**7.3.9** Thyatron

See also symbol 8.11

**7.3.9.1** With indirectly heated cathode

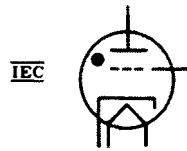

**7.4 Solion  
Ion-Diffusion Device**

**7.4.1** Diode solion

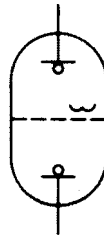

**7.4.2** Tetrode solion

NOTE — 7.4.2A: Letters in parentheses are not part of the symbol.

- I     Input
- S     Shield
- R     Readout
- C     Common

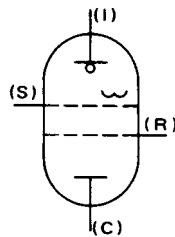

See Note 7.4.2A

### 7.5 Coulomb Accumulator Electrochemical Step-Function Device

NOTE — 7.5A: Letters in parentheses are not part of the symbol, but are for explanation only. For a precharged cell, with + polarity applied to P, the cell internal resistance and voltage drop will remain low until the designed coulomb quantity has passed; then the internal resistance will rise to its high value.

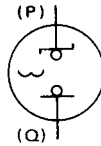

See Note 7.5A

### 7.6 Conductivity Cell



### 7.7 Nuclear-Radiation Detector (gas-filled) Ionization Chamber Proportional Counter Tube Geiger-Müller Counter Tube

NOTE — 7.7A: For other types of radiation-sensitivity indicators, see item 1.3.

#### 7.7.1 General

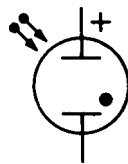

See Note 7.7A

#### 7.7.2 Application: metal enclosure, having one collector connected to the enclosure

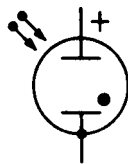

See Note 7.7A

## Cross References

Magnetron (item 15.11)

Resonator (cavity-type) Tube (item 15.10)

### NOTES:

- 1 — See Introduction for general information (note especially A3.1).
- 2 — Symbols for single-line (one-line) diagrams appear at the left, symbols for complete diagrams at the right, and symbols suitable for both purposes are centered in each column.
- 3 — For centered figures with symbols appearing side by side, the symbol on the left-hand side should be considered to be for a single line (one-line) diagram and the symbol on the right-hand side for a complete diagram, i.e., 1.5.1.

## 8. Graphic Symbols for Semiconductor Devices

### 8.1 Semiconductor Device

#### Transistor Diode

See paragraph A4.11 of the Introduction

### NOTES:

8.1A — Some semiconductor devices may be represented by either of two methods.

For convenience in referring to semiconductor symbols in this section, they are classified as follows (Symbols not otherwise identified are Style 1):

Style 1 symbols are composed of basic element symbols depicting the internal buildup of the device.

Style 2 symbols (primarily diode devices) incorporate special-property symbols into the basic-element symbol, rather than by showing the special-property symbol adjacent to the Style 1 symbols.

Style 3 symbols are composed of symbol elements representing functions of the device without regard to the method by which the function is performed within the device.

8.1B — Numbers and letters in parentheses are to correlate illustrations in the standard and are not intended to represent terminal identification.

8.1C — In general, the angle at which a lead is brought to a symbol element has no significance. IEC

8.1D — Orientation, including a mirror-image presentation, does not change the meaning of a symbol. IEC For exceptions to this rule, see item 8.3.

8.1E — The elements of the symbol must be drawn in such an order as to show clearly the operating function of the device. IEC

### 8.2 Element Symbols

#### 8.2.1 Semiconductor region with one ohmic connection

As shown, the horizontal line is the semiconductor region and the vertical line is an ohmic connection.

The line representing the ohmic connection shall not be drawn at the very end of the line representing the semiconductor region.



### 8.2.1.1 Semiconductor region with a plurality of ohmic connections

Examples show 2 ohmic connections.

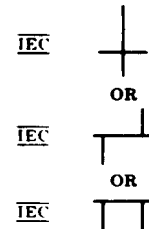

### 8.2.2 Rectifying junction or junction which influences a depletion layer

Arrowheads ( $\rightarrow|$ ) shall be half the length of the arrow away from the semiconductor base region.  $\overline{IEC}$

See item 8.6

The equilateral ( $\rightarrow\blacktriangleleft$ ) triangle shall be filled and shall touch the semiconductor base-region symbol.  $\overline{IEC}$

NOTE — 8.2.2A: The triangle points in the direction of the forward (easy) current as indicated by a direct-current ammeter, unless otherwise noted adjacent to the symbol. Electron flow is in the opposite direction.

#### 8.2.2.1 P region N region

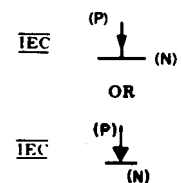

#### 8.2.2.2 N region on P region

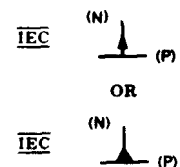

### 8.2.3 Enhancement-type semiconductor region with plurality of ohmic connections and a rectifying junction

Portions of the interrupted channel line having ohmic contacts shall be of equal length and drawn significantly longer than the center-channel section. Channel gaps shall be of equal length and approximately equal to the center-channel length.



### 8.2.4 Emitter on region of dissimilar-conductivity type

As shown, the slant line with arrow represents the emitter. Arrowheads on both the N and P emitter symbols shall be half the length of the arrow away from the semiconductor base-region symbol. IEC

Emitter element symbols shall be drawn at an angle of approximately 60 degrees to the semiconductor base-region symbol. IEC

#### 8.2.4.1 P emitter on N region

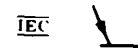

#### 8.2.4.1.1 Plurality of P emitters N on region



#### 8.2.4.2 N emitter on P region

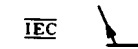

#### 8.2.4.2.1 Plurality of N emitters on P region



### 8.2.5 Collector on region of dissimilar-conductivity type

As shown, the slant line represents the collector.

Collector element symbols shall be drawn at an angle of approximately 60 degrees to the semiconductor base-region symbol. IEC

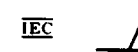

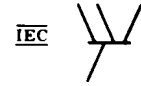
**8.2.5.1** Plurality of collectors on region of dissimilar-conductivity type**8.2.6** Transition between regions of dissimilar-conductivity types, either P to N or N to P.

The short slant line indicates point of change along the horizontal line from P to N or N to P. No connections shall be made to the short slant line. IEC

Transition-line element symbols shall be drawn at an angle of approximately 60 degrees to the semiconductor base-region symbol. IEC

The short lines used in transition symbols shall be appreciably shorter than collector or emitter symbols. IEC

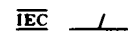
**8.2.7** Intrinsic region between 2 regions

The intrinsic region lies between the linked slant lines. IEC

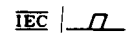
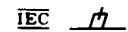
**8.2.7.1** Between regions of dissimilar-conductivity type, either PIN or NIP**8.2.7.2** Between regions of similar-conductivity type, either PIP or NIN**8.2.7.3** Between a collector and a region of dissimilar-conductivity type, either PIN or NIP

The connection to the collector is made to the long slant line. IEC

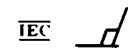
**8.2.7.4** Between a collector and a region of similar conductivity type, either PIP or NIN

The connection to the collector is made to the long slant line. IEC

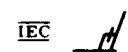

**8.2.8 Insulated gate**

The L-shaped insulated-gate element shall be drawn with one side spaced from, and parallel to, the channel between ohmic contacts. The corner of the gate element shall be drawn opposite the preferred-source ohmic contact.

**8.2.8.1 One gate**

For an application, see symbol 8.6.10.2

**8.2.8.2 Multiple gate (2 gates shown)**

For an application, see symbol 8.6.10.4.1

Insulated-gate elements are drawn as long as necessary to show each gate.

The insulated-gate element drawn opposite the preferred source is designated as the primary gate. Additional gates are secondary gates.

**8.2.9 Gate; control electrode**

Applicable only to Style 3 symbols.

NOTE — 8.2.9A: The gate symbol shall be drawn at an angle of approximately 30° to the axis of the basic diode symbol, and shall touch the cathode (or anode) symbol at a point approximately halfway between the center line of the symbol and the extremity of the cathode (or anode) symbol.

**8.2.9.1 Gate (external connection)****8.2.9.1.1 General**

For application, see symbol 8.6.12.1

Style 3



See Note 8.2.9A

**8.2.9.1.2 Having turn-off feature**

For application, see symbol 8.2.12.2

This special feature shall be indicated by a short line crossing the gate lead.

Style 3



See Note 8.2.9A

### 8.2.9.2 Gate (no external connection)

For application, see symbol 8.5.9

Because there is no external connection to the gate, this lead shall not extend to the envelope symbol, if any.

Style 3 

See Note 8.2.9A

## 8.3 Special-Property Indicators

See Note 8.1A

See also item 1.2

If necessary, a special function or property essential for circuit operation shall be indicated (a) by a supplementary symbol placed within the envelope or adjacent to the symbol, as shown in Style 1 symbols, or (b) included as part of the symbol, as shown in Style 2 symbols in item 8.5.

The orientation of the Style 1 special-property indicators with respect to the basic symbol is critical. See the applications in item 8.5.

### 8.3.1 Breakdown

Do not rotate or show in mirror-image form.

Style 1 

### 8.3.2 Tunneling

Style 1 

### 8.3.3 Backward

Style 1 

### 8.3.4 Capacitive

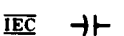
Style 1 



## 8.4 Rules for Drawing Style 1 Symbols

To draw a device symbol, start at an electrode whose polarity is known (usually an emitter) and proceed along the device, showing all of its regions individually. Finally, indicate ohmic connections where required.

NOTE — 8.4A: Numbers, letters, and words in parentheses are to correlate illustrations in the standard; they are not intended to represent device terminal numbering or identification and are not part of the symbol as shown in items 8.5, 8.6, 8.10, and 8.11.

Name of Terminal	Letter
Anode	A
Base	B
Collector	C
Drain	D
Emitter	E
Gate	G
Cathode	K
Source	S
Main terminal*	T
Substrate (bulk)	U

\*Used with bidirectional thyristors. The terminals are differentiated by numerical subscripts 1 and 2,  $T_1$  being the terminal to which the gate trigger signal is referenced, if applicable.

### 8.4.1 PNP transistor (example of a three-element device)

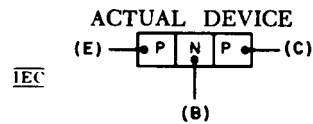

Construction of symbol by successively using symbols 8.2.4.1, 8.2.5, and 8.2.1.

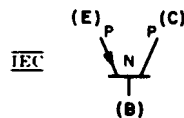

**8.4.2 PNINIP device (example of a complex device with multiple emitters and bases)**

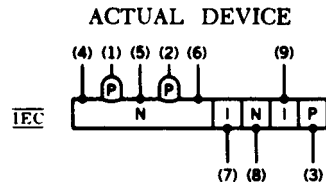

Construction of symbol by successively using symbols 8.2.4.1.1, 8.2.7.2, 8.2.7.3, and 8.2.1.1.

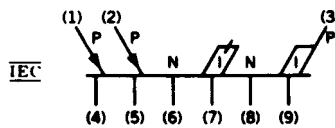

**8.5 Typical Applications, Two-Terminal Devices**

See paragraph A4.11 of the Introduction

See Note 8.4A

**8.5.1 Semiconductor diode; semiconductor rectifier diode; metallic rectifier**

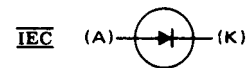

**8.5.2 Capacitive diode (varactor)**



**8.5.3 Temperature-dependent diode**

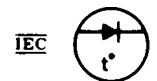

**8.5.4 Photodiode**

See item 1.3

**8.5.4.1** Photosensitive type**8.5.4.2** Photoemissive type

See also item 11.1.1

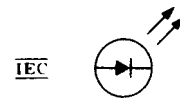
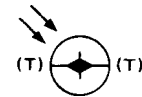
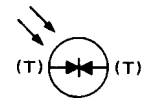
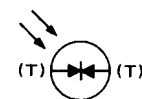
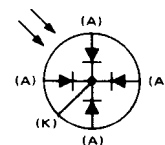
**8.5.4.3** Bidirectional photodiode; photo-duo-diode (photosensitive type)**8.5.4.3.1** NPN-type**8.5.4.3.2** PNP-type**8.5.4.4** Photosensitive type: 2-segment, with common cathode lead**8.5.4.5** Photosensitive type: 4-quadrant, with common cathode lead

**8.5.5** Storage diode**8.5.6** Breakdown diode; overvoltage absorber

See also item 9.3

**8.5.6.1** Unidirectional diode; voltage regulator

Style 1



OR



Style 2

**8.5.6.2** Bidirectional diode

Style 1

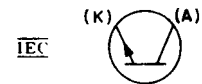
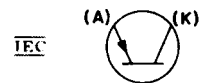

Style 2

**8.5.6.3** Unidirectional negative resistance breakdown diode; trigger diac**8.5.6.3.1** NPN-type**8.5.6.3.2** PNP-type

**8.5.6.4** Bidirectional negative-resistance breakdown diode; trigger diac

**8.5.6.4.1** NPN-type



**8.5.6.4.2** PNP-type



**8.5.7** Tunnel and backward diodes

**8.5.7.1** Tunnel diode

For this application, Note 8.2.2A does not apply.

Style 1



OR



Style 2

IEC



**8.5.7.2** Backward diode; tunnel rectifier

For this application, Note 8.2.2A does not apply.

Style 1



OR



Style 2



**8.5.8** Thyristor, reverse-blocking diode-type

**8.5.8.1** General

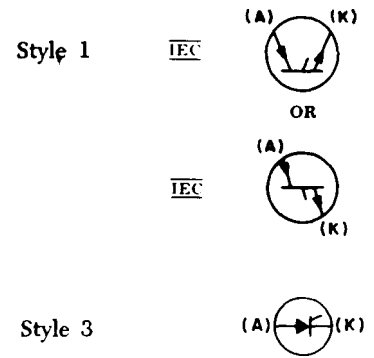

**8.5.8.2** Light-activated type

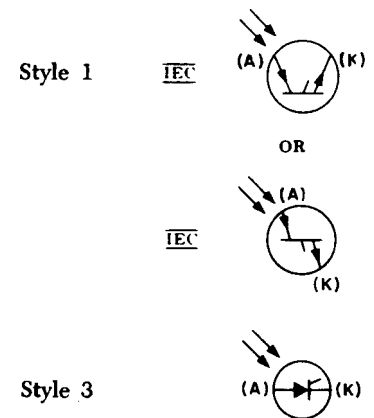

**8.5.9** Thyristor, bidirectional diode type; bi-switch

See also symbol 8.6.15

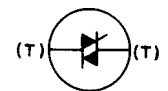

**8.5.10** Phototransistor (NPN-type) (without external base connection)

See also symbol 8.6.16, for 3-terminal device

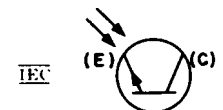

**8.5.11** Current regulator**8.5.12** PIN-type diode

NOTE — 8.5.12A: Use symbol 8.5.1 unless essential to show intrinsic region.

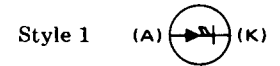
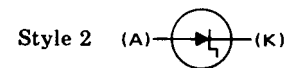
**8.5.13** Step recovery diode**8.6 Typical Applications, Three- (or more) Terminal Devices****8.6.1** PNP transistor (also PNIP transistor, if omitting the intrinsic region will not result in ambiguity)

See paragraph A4.11 of the Introduction

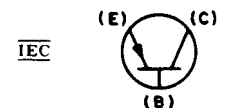
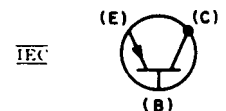
**8.6.1.1** Application: PNP transistor with one electrode connected to envelope (in this case, the collector electrode)**8.6.2** NPN transistor (also NPIN transistor, if omitting the intrinsic region will not result in ambiguity)

See paragraph A4.11 of the Introduction

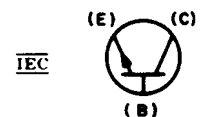

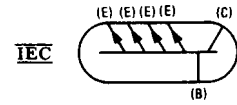
**8.6.2.1** Application: NPN transistor with multiple emitters (with 4 emitters shown)**8.6.3** NPN transistor with transverse-biased base

See paragraph A4.11 of the Introduction

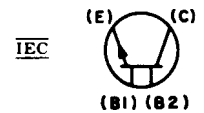
**8.6.4** PNIP transistor with ohmic connection to the intrinsic region

See paragraph A4.11 of the Introduction

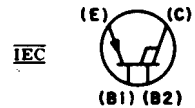
**8.6.5** NPIN transistor with ohmic connection to the intrinsic region

See paragraph A4.11 of the Introduction

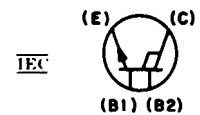
**8.6.6** PNIN transistor with ohmic connection to the intrinsic region

See paragraph A4.11 of the Introduction

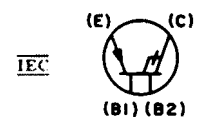



**8.6.7** NPIP transistor with ohmic connection to the intrinsic region

See paragraph A4.11 of the Introduction

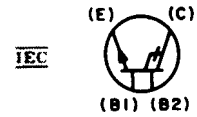
**8.6.8** Unijunction transistor with N-type base

See paragraph A4.11 of the Introduction

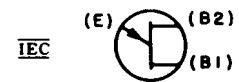
**8.6.9** Unijunction transistor with P-type base

See paragraph A4.11 of the Introduction

**8.6.10** Field-effect transistor with N-channel (junction gate and insulated gate)**8.6.10.1** N-channel junction gate

If desired, the junction-gate symbol element may be drawn opposite the preferred source.

See paragraph A4.11 of the Introduction

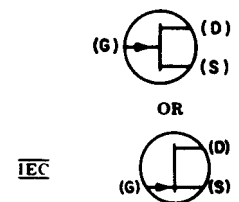
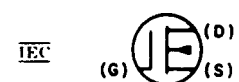
**8.6.10.2** N-channel insulated-gate, depletion-type, single-gate, passive-bulk (substrate) three-terminal device

**8.6.10.3** N-channel insulated-gate, depletion-type, single-gate, active-bulk (substrate) internally terminated to source, three-terminal device

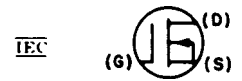

**8.6.10.4** N-channel insulated-gate, depletion-type, single-gate, active-bulk (substrate) externally terminated, four-terminal device

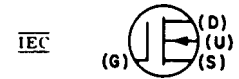

**8.6.10.4.1** Application: N-channel insulated-gate, depletion-type, two-gate, five-terminal device

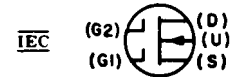

**8.6.10.5** N-channel insulated-gate, enhancement-type, single-gate, active-bulk (substrate) externally terminated, four-terminal device

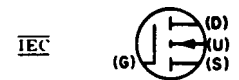

**8.6.10.5.1** Application: N-channel insulated-gate, enhancement-type, two-gate, five-terminal device

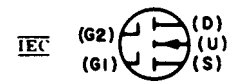

**8.6.11** Field-effect transistor with P-channel (junction gate and insulated gate)

**8.6.11.1** P-channel junction gate

See paragraph A4.11 of the Introduction

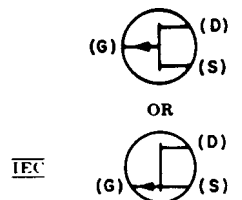

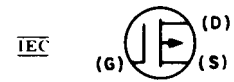
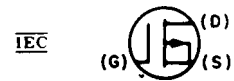
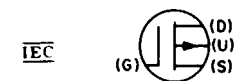
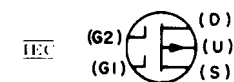
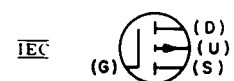
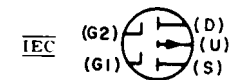
**8.6.11.2** P-channel insulated-gate, depletion-type, single-gate, passive-bulk (substrate) three-terminal device**8.6.11.3** P-channel insulated-gate, depletion-type, single-gate, active-bulk (substrate) internally terminated to source, three-terminal device**8.6.11.4** P-channel insulated-gate, depletion-type, single-gate, active-bulk (substrate) externally terminated, four-terminal device**8.6.11.4.1** Application: P-channel insulated-gate, depletion-type, two-gate, five-terminal device**8.6.11.5** P-channel insulated-gate, enhancement-type, single-gate, active-bulk (substrate) externally terminated, four-terminal device**8.6.11.5.1** Application: P-channel insulated-gate, enhancement-type, two-gate, five-terminal device**8.6.12** Thyristor, reverse-blocking triode-type, N-type gate; semiconductor controlled rectifier, N-type gate

See paragraph A4.11 of the Introduction

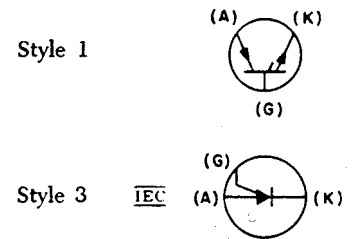
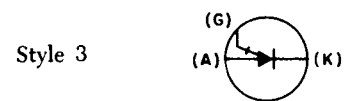
**8.6.12.1** General**8.6.12.2** Gate turn-off type**8.6.13** Thyristor, reverse-blocking triode-type, P-type gate; semiconductor controlled rectifier, P-type gate

See paragraph A4.11 of the Introduction

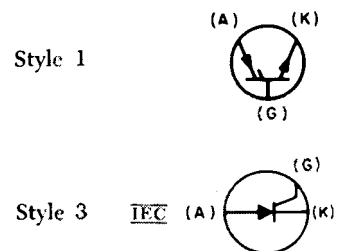
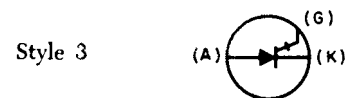
**8.6.13.1** General**8.6.13.2** Gate turn-off type

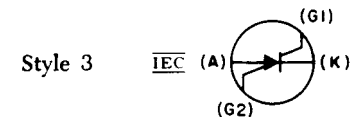
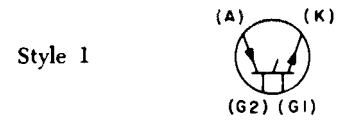
**8.6.14** Thyristor, reverse-blocking tetrode-type; semiconductor controlled switch**8.6.15** Thyristor, bidirectional triode-type; triac; gated switch

See also symbol 8.5.9

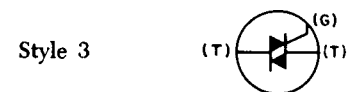
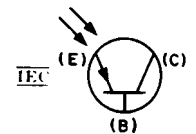
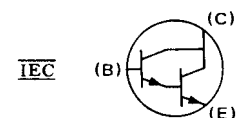
**8.6.16** Phototransistor (PNP-type) See also symbol 8.5.10, for 2-terminal device**8.6.17** Darlington transistor (NPN-type)**8.7 Photosensitive Cell**

See paragraph A4.11 of the Introduction

**8.7.1** Asymmetrical photoconductive transducer

USE SYMBOL 8.5.4.1

**8.7.2** Symmetrical photoconductive transducer (resistive)

USE SYMBOL 2.1.13

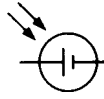
**8.7.3** Photovoltaic transducer; barrier photocell; blocking-layer cell; solar cell**8.8 Semiconductor Thermocouple****8.8.1** Temperature-measuring

See paragraph A4.11 of the Introduction

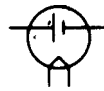
**8.8.2** Current-measuring**8.9 Hall Element  
Hall Generator**

See paragraph A4.11 of the Introduction

NOTE — 8.9A: W and X are the current terminals; Y and Z are the voltage output terminals. Letters are for explanation and are not part of the symbol.

If polarity markings (symbol 1.6) are shown, the direction of the magnetic field must be defined.

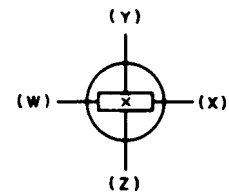

See Note 8.9A

**8.10 Photon-Coupled Isolator**

See also symbol 15.8.1

NOTE — 8.10A: T is the transmitter; R is the receiver. The letters are for explanation and are not part of the symbol. Explanatory information should be added to explain circuit operation.

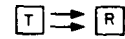
**8.10.1** General

See Note 8.10A

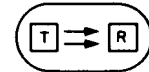
**8.10.2** Complete isolator (single-package type)

See Note 8.2.9A

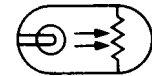
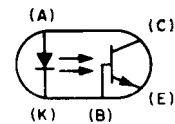
**8.10.3** Application: Incandescent lamp and symmetrical photoconductive transducer**8.10.4** Application: Photoemissive diode and phototransistor**8.11 Solid-State Thyatron (replacement type)**

See symbol 7.3.9

NOTE — 8.11A: If the thyatron replacement has only one cathode lead, see symbol 8.6.13.1, Style 3.

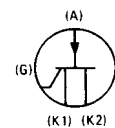
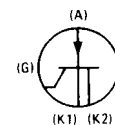
**8.11.1** Balanced**8.11.2** Unbalanced

## Cross References

### Bridge-Type Rectifier

(item 16.3.3)

#### NOTES:

- 1 — See Introduction for general information (note especially A3.1).
- 2 — Symbols for single-line (one-line) diagrams appear at the left, symbols for complete diagrams at the right, and symbols suitable for both purposes are centered in each column.
- 3 — For centered figures with symbols appearing side by side, the symbol on the left-hand side should be considered to be for a single line (one-line) diagram and the symbol on the right-hand side for a complete diagram, i.e., 1.5.1.

## 9. Graphic Symbols for Circuit Protectors

### 9.1 Fuse (one-time thermal current-overload device)

#### 9.1.1 General

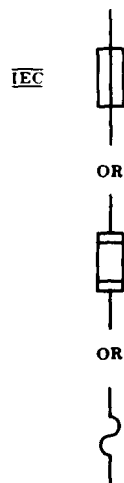

#### 9.1.1.1 Fuse, supply side indicated by a thick line



#### 9.1.2 Fuse with alarm contact

NOTE — 9.1.2A: When fuse blows, alarm bus A is connected to power supply bus S. The letters S (supply), L (load), and A (alarm circuit) are for explanation only, and are not part of the symbol.



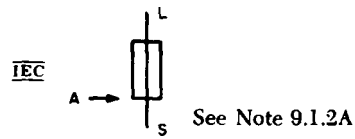

**9.1.3** Isolating fuse-switch; high-voltage primary fuse cutout, dry



**9.1.4** High-voltage primary fuse cutout, oil

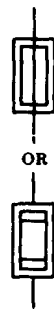

**9.1.5** Isolating fuse-switch for on-load switching



**9.1.6** Temperature-sensitive fuse (ambient-temperature operated)

USE SYMBOL 2.12.3

**9.2 Current Limiter (for power cable)**

The arrowheads in this case are filled.

NOTE — 9.2A: Use appropriate number of single-line diagram symbols.



See Note 9.2A

Avoid conflict with symbol 1.7.3 if used on the same diagram.

### 9.3 Lightning Arrester $\square$ Arrester (electric surge, etc) Gap

See also symbol 8.5.6

#### 9.3.1 General



#### 9.3.2 Carbon block; telephone protector block $\square$

The sides of the rectangle shall be approximately in the ratio of 1 to 2 and the space between rectangles shall be approximately equal to the width of a rectangle.

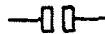

#### 9.3.3 Electrolytic or aluminum cell

This symbol is not composed of arrowheads.



#### 9.3.4 Horn gap



#### 9.3.5 Protective gap

These triangles shall not be filled.



#### 9.3.6 Sphere gap

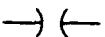

#### 9.3.7 Valve or film element



### 9.3.8 Multigap, general



### 9.3.9 Application: gap plus valve plus ground, 2-pole



## 9.4 Circuit Breaker E

If it is desired to show the condition causing the breaker to trip, the relay protective-function symbols in item 9.5.1 may be used alongside the breaker symbol.

### 9.4.1 General

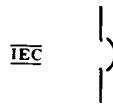

**9.4.2** Air circuit breaker, if distinction is needed; for alternating-current circuit breakers rated at 1,500 volts or less and for all direct-current circuit breakers

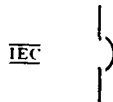

### 9.4.3 Network protector



### 9.4.4 Circuit breaker, other than covered by symbol 9.4.1

The symbol in the right column is for a 3-pole breaker.

NOTE — 9.4.4A: On a power diagram, the symbol may be used without other identification. On a composite drawing where confusion with the general circuit element symbol (item 16.1) may result, add the identifying letters CB inside or adjacent to the square.

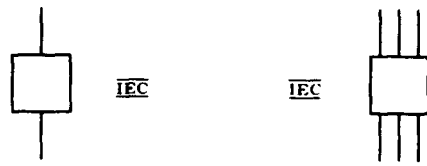

See Note 9.4.4A

#### 9.4.5 Application: 3-pole circuit breaker with thermal-overload device in all 3 poles

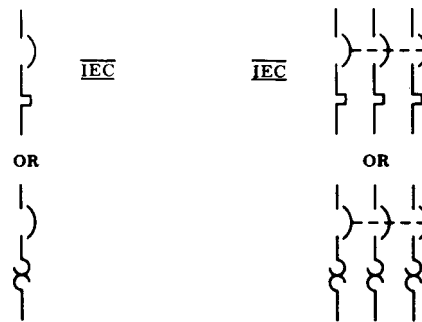

#### 9.4.6 Application: 3-pole circuit breaker with magnetic-overload device in all 3 poles

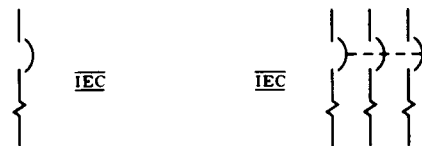

#### 9.4.7 Application: 3-pole circuit breaker, drawout type



### 9.5 Protective Relay

Fundamental symbols for contacts, coils, mechanical connections, etc, are the basis of relay symbols and should be used to represent relays on complete diagrams.

See RELAY COIL; OPERATING COIL (item 4.5) and RELAY (item 4.30)

**9.5.1** Relay protective functions

The following symbols may be used to indicate protective functions, or device-function numbers may be placed in the circle or adjacent to the basic symbol (see American National Standard for Manual and Automatic Station Control, Supervisory, and Associated Telemetering Equipments, C37.2-1970).

NOTE — 9.5.1A: An operating-quantity symbol must be added to the general symbols 9.5.2 through 9.5.6 in accordance with the rules of 9.5.9.

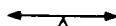
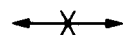
**9.5.2** Over, general**9.5.3** Under, general**9.5.4** Direction, general; directional over**9.5.5** Balance, general**9.5.6** Differential, general**9.5.7** Pilot wire, general**9.5.8** Carrier current, general**9.5.9** Operating quantity

The operating quantity is indicated by the following letters or symbols placed either on or immediately above the relay protective-function symbols shown above.

C      Current<sup>13</sup>

<sup>13</sup>The use of the letter may be omitted in the case of current, and the absence of such letter presupposes that the relay operates on current.

Z	Distance
F	Frequency
GP	Gas pressure
$\phi$	Phase
W	Power
S	Synchronism
T	Temperature
V	Voltage

### 9.5.10 Ground relays

Relays operative on residual current only are so designated by attaching the ground symbol



to the relay protective-function symbol. Note that the zero phase-sequence designation given below may be used instead when desirable.

### 9.5.11 Phase-sequence quantities

Operations on phase-sequence quantities may be indicated by the use of the conventional subscripts 0, 1, and 2 after the letter indicating the operating quantity.

### 9.5.12 Applications

#### 9.5.12.1 Overcurrent



#### 9.5.12.2 Directional overcurrent



#### 9.5.12.3 Directional residual overcurrent



#### 9.5.12.4 Undervoltage

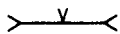

#### 9.5.12.5 Power directional

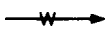

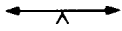
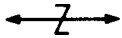
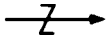
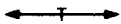
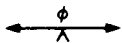

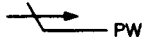
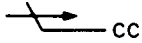
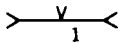
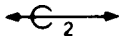
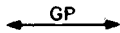
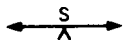
**9.5.12.6** Balanced current**9.5.12.7** Differential current**9.5.12.8** Distance**9.5.12.9** Directional distance**9.5.12.10** Overfrequency**9.5.12.11** Overtemperature**9.5.12.12** Phase balance**9.5.12.13** Phase sequence**9.5.12.14** Pilot wire, differential-current

**9.5.12.15** Pilot wire, directional-comparison**9.5.12.16** Carrier pilot**9.5.12.17** Positive phase-sequence undervoltage**9.5.12.18** Negative phase-sequence overcurrent**9.5.12.19** Gas-pressure (Buchholz)**9.5.12.20** Out-of-step**Cross References**

## NOTES:

- 1 — See Introduction for general information (note especially A3.1).
- 2 — Symbols for single-line (one-line) diagrams appear at the left, symbols for complete diagrams at the right, and symbols suitable for both purposes are centered in each column.
- 3 — For centered figures with symbols appearing side by side, the symbol on the left-hand side should be considered to be for a single line (one-line) diagram and the symbol on the right-hand side for a complete diagram, i.e., 1.5.1.

**10. Graphic Symbols for Acoustic Devices****10.1 Audible-Signaling Device****10.1.1** Bell, electrical ; telephone ringer 

NOTE — 10.1.1A: If specific identification is required, the abbreviation AC (or symbol 1.8.2) or DC (or lower symbol 1.8.1) may be added within or adjacent to the symbol.



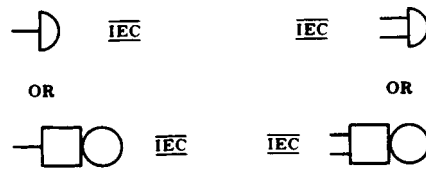

See Note 10.1.1A

#### 10.1.1.1 Single-stroke



#### 10.1.2 Buzzer



#### 10.1.3 Loudspeaker

Horn, Electrical

Siren

Underwater Sound Transducer (with acoustic output)

Sound Reproducer

##### 10.1.3.1 General



##### 10.1.3.2 Application: specific types

If specific identification of loudspeaker types is required, the following letter combinations may be added in the symbol at the locations indicated by the \* and the ‡:

- \* HN Horn, electrical
- \* HW Howler
- \* LS Loudspeaker
- \* SN Siren
- ‡ EM Electromagnetic with moving coil (moving-coil leads should be identified)
- ‡ EMN Electromagnetic with moving coil and neutralizing winding (moving-coil leads should be identified)
- ‡ MG Magnetic armature
- ‡ PM Permanent magnet with moving coil

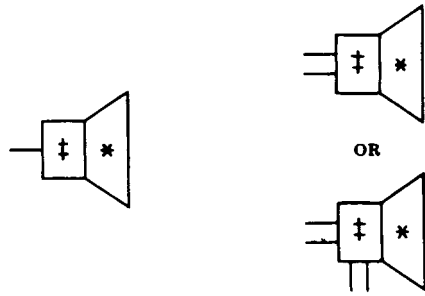

Note: The \* and † are not part of the symbol.

**10.1.3.3** Loudspeaker-microphone; underwater sound transducer, two-way

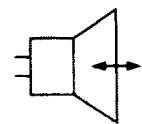

**10.1.4** Telegraph sounder



**10.2 Microphone Telephone Transmitter**

**10.2.1** General

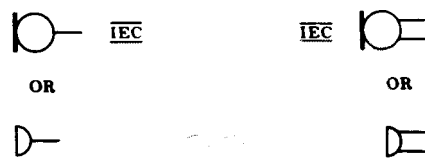

**10.3 Handset Operator's Set**

**10.3.1** General



**10.3.2** With push-to-talk switch



**10.3.3** 3-conductor handset



**10.3.4** 4-conductor handset

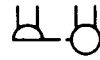

**10.3.5** 4-conductor handset with push-to-talk switch



**10.3.6** Operator's set



**10.4 Telephone Receiver**  
**Earphone**   
**Hearing-Aid Receiver**

**10.4.1** General

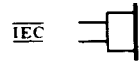
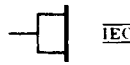

**10.4.2** Headset, double



**10.4.3 Headset, single****Cross References**

## NOTES:

- 1 — See Introduction for general information (note especially A3.1).
- 2 — Symbols for single-line (one-line) diagrams appear at the left, symbols for complete diagrams at the right, and symbols suitable for both purposes are centered in each column.
- 3 — For centered figures with symbols appearing side by side, the symbol on the left-hand side should be considered to be for a single line (one-line) diagram and the symbol on the right-hand side for a complete diagram, i.e., 1.5.1.

**11. Graphic Symbols for Lamps and Visual-Signaling Devices****11.1 Lamp**

See also item 8.5.4.2

**11.1.1 Lamp, general; high source, general**

See also item 11.2.7



## NOTES:

11.1.1A — This symbol may be used to represent one or more lamps with or without operating auxiliaries.

11.1.1B — If it is essential to indicate the following characteristics, the specified letter or letters may be inserted within or placed adjacent to the symbol.

A	Amber
B	Blue
C	Clear
G	Green
O	Orange
OP	Opalescent
P	Purple
R	Red
W	White
Y	Yellow
ARC	Arc
EL	Electroluminescent
FL	Fluorescent
HG	Mercury vapor

IN	Incandescent
IR	Infrared
NA	Sodium vapor
NE	Neon
UV	Ultraviolet
XE	Xenon
LED	Light-emitting diode

11.1.1C — For polarity-sensitive devices, identify the appropriate lead with the (+) polarity mark.

### 11.1.2 Fluorescent lamp

#### 11.1.2.1 2-terminal

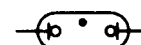

#### 11.1.2.2 4-terminal

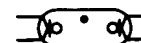

### 11.1.3 Glow lamp , cold-cathode lamp; neon lamp

#### 11.1.3.1 Alternating-current type

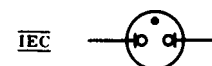

#### 11.1.3.2 Direct-current type

See also ELECTRON TUBE (symbol 7.3.4.1)

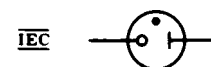

### 11.1.4 Incandescent lamp (incandescent-filament illuminating lamp)



### 11.1.5 Ballast lamp; ballast tube

The primary characteristic of the element within the circle is designed to vary non-linearly with the temperature of the element.

See paragraph A4.11 of the Introduction

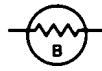

### 11.1.6 Electronic flash tube (lamp)

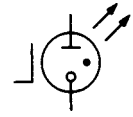

## 11.2 Visual-Signaling Device

### 11.2.1 Annunciator (general)

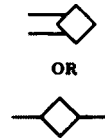

### 11.2.2 Annunciator drop or signal, shutter or grid type



### 11.2.3 Annunciator drop or signal, ball type

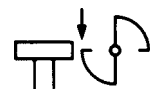

### 11.2.4 Manually restored drop

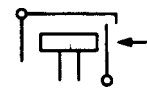

### 11.2.5 Electrically restored drop



**11.2.6** Communication switchboard-type lamp; indicating lamp**11.2.7** Indicating, pilot, signaling, or switchboard light; indicator light ; signal light 

NOTE — 11.2.7A: The asterisk is not part of the circular symbol. Always add the letter or letters for colors specified in Note 11.1.1B within or adjacent to the circle. To avoid confusion with meter or basic relay symbols, add suffix L or IL to the letter or letters, for example, RL or RIL placed within or adjacent to the circle.

If confusion with other circular symbols may occur, the D-shaped symbol should be used.

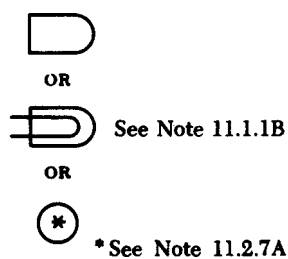

Avoid conflict with symbols 4.5, 12.1.1, and 13.1.2 if used on the same diagram.

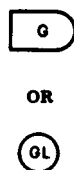
**11.2.7.1** Application: green signal light**11.2.8** Jeweled signal light**Cross References**

## NOTES:

- 1 — See Introduction for general information (note especially A3.1).
- 2 — Symbols for single-line (one-line) diagrams appear at the left, symbols for complete diagrams at the right, and symbols suitable for both purposes are centered in each column.
- 3 — For centered figures with symbols appearing side by side, the symbol on the left-hand side should be considered to be for a single line (one-line) diagram and the symbol on the right-hand side for a complete diagram, i.e., 1.5.1.

## 12. Graphic Symbols for Readout Devices

### 12.1 Meter

#### Instrument





NOTE — 12.1A: The asterisk is not part of the symbol. Always replace the asterisk by one of the following letter combinations, depending on the function of the meter or instrument, unless some other identification is provided in the circle and explained on the diagram.



\* See Note 12.1A

A	Ammeter $\overline{\text{IEC}}$
AH	Ampere-hour meter
C	Coulombmeter
CMA	Contact-making (or breaking) ammeter
CMC	Contact-making (or breaking) clock
CMV	Contact-making (or breaking) voltmeter
CRO	Oscilloscope $\overline{\text{IEC}}$ Cathode-ray oscillograph
DB	DB (decibel) meter Audio level/meter $\overline{\text{IEC}}$
DBM	DBM (decibels referred to 1 milliwatt) meter
DM	Demand meter
DTR	Demand-totalizing relay
F	Frequency meter $\overline{\text{IEC}}$
GD	Ground detector
I	Indicating meter
INT	Integrating meter
$\mu\text{A}$ or UA	Microammeter
MA	Milliammeter
NM	Noise meter
OHM	Ohmmeter $\overline{\text{IEC}}$
OP	Oil pressure meter
OSCG	Oscillograph, string
PF	Power factor meter
PH	Phasemeter $\overline{\text{IEC}}$
PI	Position indicator
RD	Recording demand meter
REC	Recording meter
RF	Reactive factor meter
SY	Synchroscope
$t^\circ$	Temperature meter
THC	Thermal converter
TLM	Telemeter
TT	Total time meter Elapsed time meter
V	Voltmeter $\overline{\text{IEC}}$
VA	Volt-ammeter



VAR	Varmeter 
VARH	Varhour meter
VI	Volume indicator
	Audio-level meter 
VU	Standard volume indicator
	Audio-level meter 
W	Wattmeter  
WH	Watthour meter

### 12.1.1 Galvanometer

Avoid conflict with symbols 4.5 and 13.1.2 if used on the same diagram.

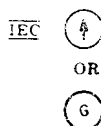

## 12.2 Electromagnetically Operated Counter Message Register

### 12.2.1 General



### 12.2.2 With make contact



## Cross References

### NOTES:

- 1 — See Introduction for general information (note especially A3.1).
- 2 — Symbols for single-line (one-line) diagrams appear at the left, symbols for complete diagrams at the right, and symbols suitable for both purposes are centered in each column.
- 3 — For centered figures with symbols appearing side by side, the symbol on the left-hand side should be considered to be for a single line (one-line) diagram and the symbol on the right-hand side for a complete diagram, i.e., 1.5.1.

## 13. Graphic Symbols for Rotating Machinery

### 13.1 Rotating Machine

#### 13.1.1 Basic



#### 13.1.2 Generator $\square$ (general)

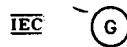

Avoid conflict with symbols 12.1.1 and 21.5.1 if used on the same diagram.

OR



#### 13.1.2.1 Generator, direct-current



#### 13.1.2.2 Generator, alternating-current

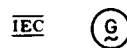

#### 13.1.2.3 Generator, synchronous

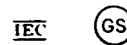

#### 13.1.3 Motor $\square$ (general)

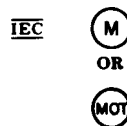

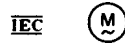
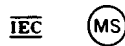
**13.1.3.1** Motor, direct-current**13.1.3.2** Motor, alternating-current**13.1.3.3** Motor, synchronous**13.1.4** Motor, multispeed

USE SYMBOLS 13.1.3 AND NOTE SPEEDS

**13.1.5**<sup>14</sup> Rotating armature with commutator and brushes**13.1.6** Hand generator**13.2 Field, Generator or Motor**

Either symbol of item 6.2.1 may be used in the following items.

**13.2.1** Compensating or commutating**13.2.2** Series

<sup>14</sup>The broken line - — - indicates where line connection to a symbol is made and is not part of the symbol.

**13.2.3** Shunt, or separately excited**13.2.4** Permanent magnet

USE SYMBOL 2.8

**13.3 Winding Connection Symbols**

Motor and generator winding connection symbols may be shown in the basic circle using the following representations.

**13.3.1** 1-phase**13.3.2** 2-phase**13.3.3** 3-phase wye (ungrounded)**13.3.4** 3-phase wye (grounded)**13.3.5** 3-phase delta**13.3.6** 6-phase diametrical

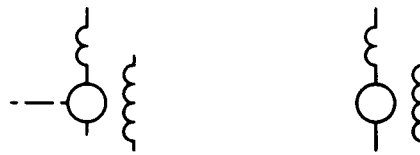
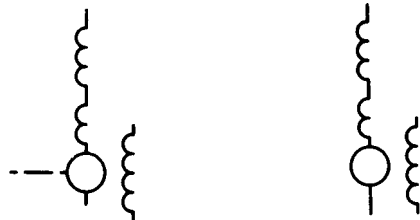
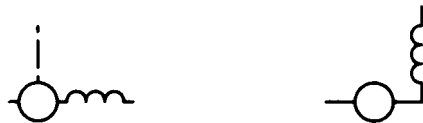
**13.3.7** 6-phase double-delta**13.4 Applications: Direct-Current Machines****13.4.1**<sup>15</sup> Separately excited direct-current generator or motor**13.4.2**<sup>15</sup> Separately excited direct-current generator or motor; with commutating or compensating field winding, or both**13.4.3**<sup>15</sup> Compositely excited direct-current generator or motor; with commutating or compensating field winding, or both**13.4.4**<sup>15</sup> Direct-current series motor or 2-wire generator<sup>15</sup>The broken line - - - indicates where line connection to a symbol is made and is not part of the symbol.

**13.4.5**<sup>16</sup> Direct-current series motor or 2-wire generator; with commutating or compensating field winding, or both

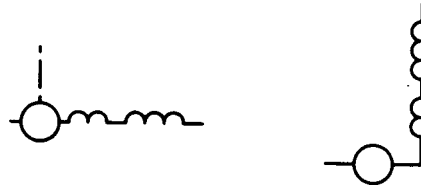

**13.4.6**<sup>16</sup> Direct-current shunt motor or 2-wire generator



**13.4.7**<sup>16</sup> Direct-current shunt motor or 2-wire generator; with commutating or compensating field winding, or both

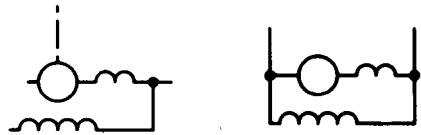

**13.4.8**<sup>16</sup> Direct-current permanent-magnet-field generator or motor



**13.4.9**<sup>16</sup> Direct-current compound motor or 2-wire generator or stabilized shunt motor



<sup>16</sup>The broken line - - - indicates where line connection to a symbol is made and is not part of the symbol.

**13.4.10**<sup>17</sup> Direct-current compound motor or 2-wire generator or stabilized shunt motor; with commutating or compensating field winding, or both

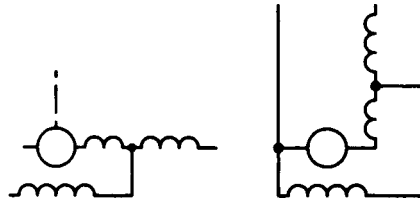

**13.4.11**<sup>17</sup> Direct-current 3-wire shunt generator



**13.4.12**<sup>17</sup> Direct-current 3-wire shunt generator; with commutating or compensating field winding, or both

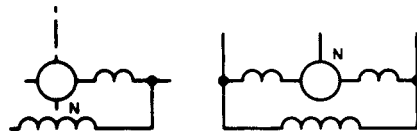

**13.4.13**<sup>17</sup> Direct-current 3-wire compound generator



**13.4.14**<sup>17</sup> Direct-current 3-wire compound generator; with commutating or compensating field winding, or both

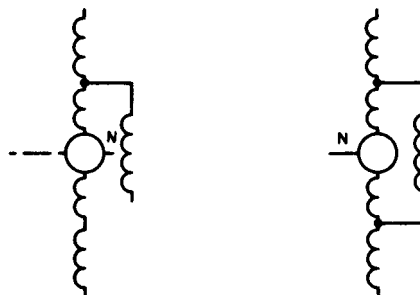

<sup>17</sup>The broken line - - - indicates where line connection to a symbol is made and is not part of the symbol.

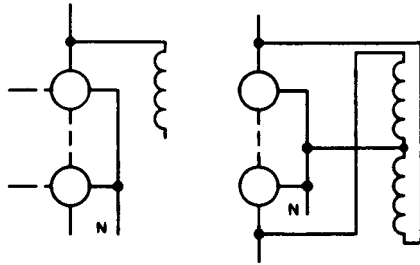
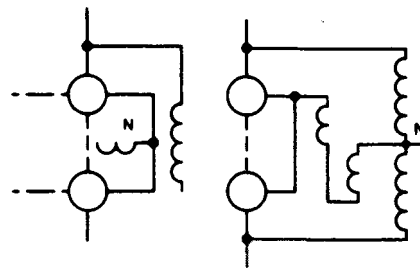
**13.4.15**<sup>18</sup> Direct-current balancer, shunt wound**13.4.16**<sup>18</sup> Direct-current balancer, compound wound**13.4.17**<sup>18</sup> Dynamotor**13.4.18**<sup>18</sup> Double-current generator**13.4.19**<sup>18</sup> Acyclic generator, separately excited<sup>18</sup>The broken line - - - indicates where line connection to a symbol is made and is not part of the symbol.

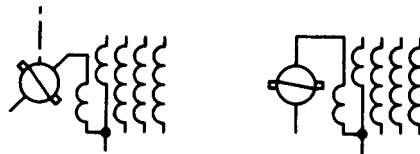
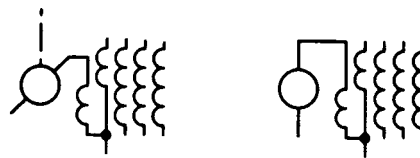
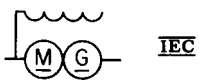

**13.4.20**<sup>19</sup> Regulating generator (rotary amplifier), shunt wound with short-circuited brushes**13.4.21**<sup>19</sup> Regulating generator (rotary amplifier), shunt wound without short-circuited brushes**13.4.22**<sup>19</sup> Regulating generator (rotary amplifier), shunt wound with compensating field winding and short-circuited brushes**13.4.23**<sup>19</sup> Regulating generator (rotary amplifier), shunt wound with compensating field winding, without short-circuited brushes**13.4.24** DC-to-dc rotary converter with common permanent magnetic field**13.4.25** DC-to-dc rotary converter with common field winding<sup>19</sup>The broken line - - - indicates where line connection to a symbol is made and is not part of the symbol.

### 13.5 Applications: Alternating-Current Machines

**13.5.1**<sup>20</sup> Squirrel-cage induction motor or generator, split-phase induction motor or generator, rotary phase converter, or repulsion motor



**13.5.2**<sup>20</sup> Wound-rotor induction motor, synchronous induction motor, induction generator, or induction frequency converter



**13.5.3**<sup>20</sup> Alternating-current series motor



**13.5.4**<sup>20</sup> Alternating-current series motor, with commutating or compensating field winding, or both



**13.5.5**<sup>20</sup> 1-phase shaded-pole motor



**13.5.6**<sup>20</sup> 1-phase repulsion-start induction motor



<sup>20</sup>The broken line - - - indicates where line connection to a symbol is made and is not part of the symbol.

**13.5.7** <sup>21</sup> 1-phase hysteresis motor**13.5.8** <sup>21</sup> Reluctance motor**13.5.9** <sup>21</sup> 1-phase subsynchronous reluctance motor**13.5.10** <sup>21</sup> Magnetolectric generator, 1-phase; telephone magneto**13.5.11** <sup>21</sup> Shunt-characteristic brush-shifting motor**13.5.12** <sup>21</sup> Series-characteristic brush-shifting motor with 3-phase rotor**13.5.13** Series-characteristic brush-shifting motor with 6- or 8-phase rotor

<sup>21</sup>The broken line - - - indicates where line connection to a symbol is made and is not part of the symbol.

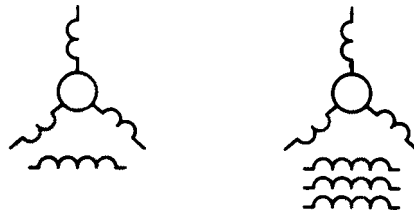
**13.5.14** Ohmic-drop exciter with 3- or 6-phase input**13.5.15** Ohmic-drop exciter with 3- or 6-phase input, with output leads**13.5.16** 3-phase regulating machine**13.5.17** Phase shifter with 1-phase output

See PHASE SHIFTER (item 16.6) and TRANSFORMER (item 6.4)

**13.5.18** Phase shifter with 3-phase output

See PHASE SHIFTER (item 16.6) and TRANSFORMER (item 6.4)



## 13.6 Applications: Alternating-Current Machines with Direct-Current Field Excitation

### 13.6.1 <sup>22</sup> Synchronous motor, generator, or condenser



### 13.6.2 <sup>22</sup> Synchronous motor, generator, or condenser with neutral brought out



### 13.6.3 <sup>22</sup> Synchronous motor, generator, or condenser with both ends of each phase brought out



### 13.6.4 <sup>22</sup> Double-winding synchronous generator, motor, or condenser



### 13.6.5 <sup>22</sup> Synchronous-synchronous frequency changer

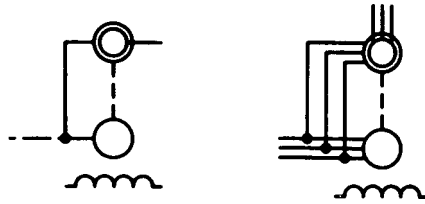
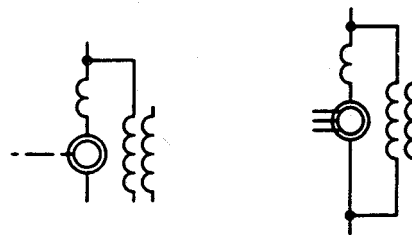
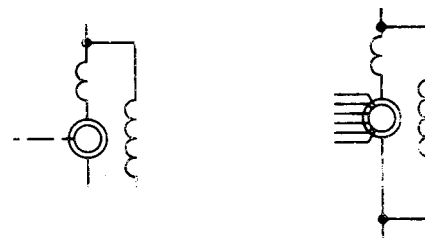

<sup>22</sup>The broken line - - - indicates where line connection to a symbol is made and is not part of the symbol.

**13.6.6**<sup>23</sup> Synchronous-induction frequency changer**13.7 Applications: Alternating- and Direct-Current Composite****13.7.1**<sup>23</sup> Synchronous or regulating-pole converter**13.7.2**<sup>23</sup> Synchronous booster or regulating-pole converter; with commutating or compensating field windings, or both**13.7.3**<sup>23</sup> Synchronous converter, shunt-wound with commutating or compensating field windings, or both

<sup>23</sup>The broken line - - - indicates where line connection to a symbol is made and is not part of the symbol.

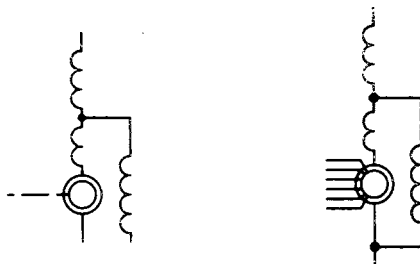
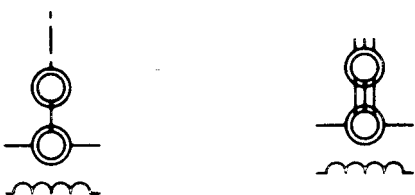
**13.7.4**<sup>24</sup> Synchronous converter, compound-wound with commutating or compensating field windings, or both**13.7.5**<sup>24</sup> Motor converter**13.8 Synchro** 

If identification is required, a letter combination from the following list shall be placed adjacent to the symbol to indicate the type of synchro.

CDX	Control-differential transmitter
CT	Control transformer
CX	Control transmitter
TDR	Torque-differential receiver
TDX	Torque-differential transmitter
TR	Torque receiver
TX	Torque transmitter
RS	Resolver



If the outer winding is rotatable in bearings, the suffix B shall be added to the above letter combinations.

**13.8.1** General

Complete symbols may also be formed by using the winding symbol 6.2.1.



<sup>24</sup>The broken line - - - indicates where line connection to a symbol is made and is not part of the symbol.

**13.8.2** Synchro, control transformer; synchro, receiver  synchro, transmitter 



**13.8.3** Synchro, differential receiver; synchro, differential transmitter 



**13.8.4** Synchro, resolver 

Type shown: 2-phase rotor and 2-phase stator



## Cross References

## 14. Graphic Symbols for Mechanical Functions

### 14.1 Mechanical Connection Mechanical Interlock

The preferred location of the mechanical connection is as shown in the various applications, but other locations may be equally acceptable.

#### 14.1.1 Mechanical connection

The top symbol consists of short dashes.

NOTE — 14.1.1A: The short parallel lines should be used only where there is insufficient space for the short dashes in series. See symbol 4.9.3 for application.

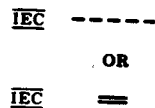

See Note 14.1.1A



**14.1.2** Mechanical connection or interlock with fulcrum

These are short dashes.

**14.1.3** Mechanical interlock, other

INDICATE BY A NOTE

**14.2 Mechanical Motion****14.2.1** Translation, one direction**14.2.2** Translation, both directions**14.2.3** Rotation, one direction**14.2.3.1** Application: angular motion, applied to open contact (make), symbol 4.3.2

NOTE — 14.2.3.1A: The asterisk is not part of the symbol. Explanatory information (similar to type shown) may be added if necessary to explain circuit operation.

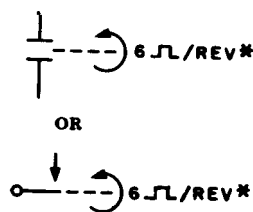

\* See Note 14.2.3.1A

**14.2.4** Rotation, both directions**14.2.4.1** Alternating or reciprocating

For application see symbol 2.3.7.7

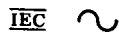

### 14.2.5 Rotation designation (applied to a resistor)

CW indicates position of adjustable contact at the limit of clockwise travel viewed from knob or actuator end unless otherwise indicated.

NOTE — 14.2.5A: The asterisk is not part of the symbol. Always add identification within or adjacent to the rectangle.

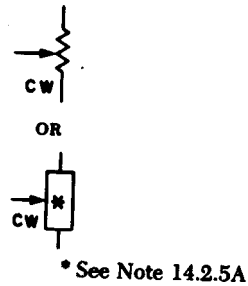

### 14.2.6 Rotational speed or angular velocity dependence, shown with rotational arrow

See symbol 4.24.4 for application



## 14.3 Clutch Brake

### 14.3.1 Clutch disengaged when operating means (not shown) is deenergized or nonoperated

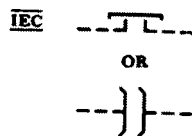

### 14.3.2 Clutch engaged when operating means (not shown) is deenergized or nonoperated

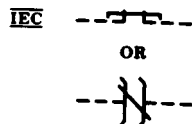

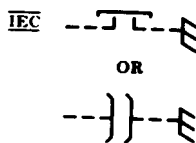
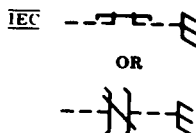
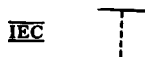
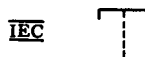
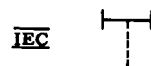
**14.3.3** Brake applied when operating means (not shown) is energized**14.3.4** Brake released when operating means (not shown) is energized**14.4 Manual Control****14.4.1** General**14.4.2** Operated by pushing**14.4.3** Operated by pushing and pulling (push-pull)**Cross References**

## NOTES:

- 1 — See Introduction for general information (note especially A3.1).
- 2 — Symbols for single-line (one-line) diagrams appear at the left, symbols for complete diagrams at the right, and symbols suitable for both purposes are centered in each column.
- 3 — For centered figures with symbols appearing side by side, the symbol on the left-hand side should be considered to be for a single line (one-line) diagram and the symbol on the right-hand side for a complete diagram, i.e., 1.5.1.

## 15. Graphic Symbols Commonly Used in Connection with VHF, UHF, SHF Circuits

### 15.1 Discontinuity (Introducing intentional wave reflection)

A component that exhibits throughout the frequency range of interest the properties of the type of circuit element indicated by the symbol within the triangle.

Commonly used for coaxial and waveguide transmission.

#### 15.1.1<sup>25</sup> General



##### 15.1.1.1 Terminal discontinuity (one-port)



##### 15.1.1.2 Discontinuity (two-port)

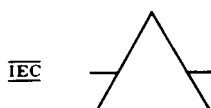

#### 15.1.2 Equivalent series element, general, in series with guided transmission path

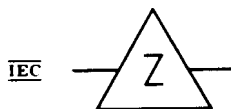

##### 15.1.2.1 Capacitive reactance

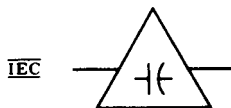

<sup>25</sup>The broken line - - - indicates where line connection to a symbol is made and is not part of the symbol.

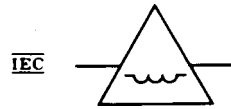
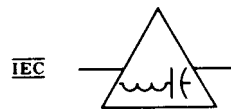
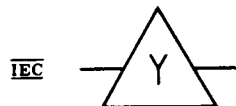
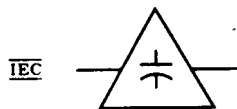
**15.1.2.2** Inductive reactance**15.1.2.3** Resistance**15.1.2.4** Inductance-capacitance circuit with zero reactance at resonance**15.1.2.5** Inductance-capacitance circuit with infinite reactance at resonance**15.1.3** Equivalent shunt element, general, in parallel with guided transmission path**15.1.3.1** Capacitive susceptance**15.1.3.2** Inductive susceptance

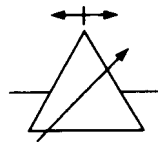
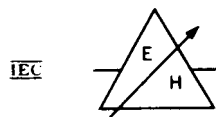
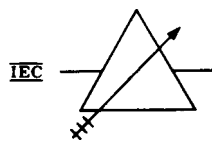
**15.1.3.3** Conductance**15.1.3.4** Inductance-capacitance circuit having zero reactance, infinite susceptance at resonance**15.1.3.5** Inductance-capacitance circuit having infinite reactance, zero susceptance at resonance**15.1.4** Slide-screw tuner**15.1.5** E-H tuner**15.1.6** Multistub tuner with 3 stubs**15.2** Coupling

Commonly used in coaxial and waveguide diagrams.

**15.2.1** Coupling by aperture with an opening of less than full waveguide size

Transmission loss may be indicated.

NOTE — 15.2.1A: The asterisk is not part of the symbol. Always replace the asterisk by E, H, or HE, depending on the type of coupling.

E	indicates that the physical plane of the aperture is perpendicular to the transverse component of the major E lines.
H	indicates that the physical plane of the aperture is parallel to the transverse component of the major E lines.
HE	indicates coupling by all other kinds of apertures.

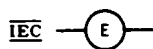
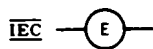
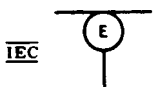
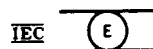
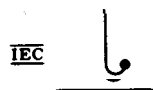
**15.2.1.1** Application: E-plane coupling by aperture to space**15.2.1.2** Application: E-plane coupling by aperture; 2 ends of transmission path available**15.2.1.3** Application: E-plane coupling by aperture; 3 ends of transmission path available**15.2.1.4** Application: E-plane coupling by aperture; 4 ends of transmission path available**15.2.2** Coupling by loop to space**15.2.3** Coupling by loop to guided transmission path

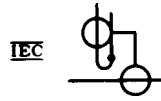
**15.2.4** Coupling by loop from coaxial to circular waveguide with direct-current grounds connected**15.2.5** Coupling by probe to space

See OPEN CIRCUIT (item 3.8.1)

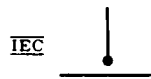
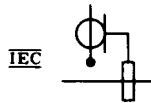
**15.2.6** Coupling by probe to guided transmission path**15.2.7** Coupling by probe from coaxial to rectangular waveguide with direct-current grounds connected**15.3 Directional Coupler** 

Commonly used in coaxial and waveguide diagrams.

The arrows indicate the directions of power flow.

Number of coupling paths, type of coupling, and transmission loss may be indicated.

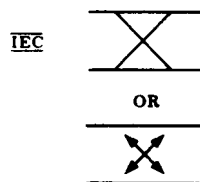
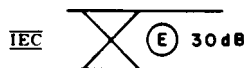
**15.3.1** General**15.3.2** Application: E-plane aperture coupling, 30-decibel transmission loss

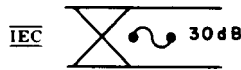
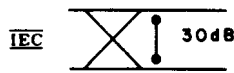

**15.3.3** Application: loop coupling, 30-decibel transmission loss**15.3.4** Application: probe coupling, 30-decibel transmission loss**15.3.5** Application: resistance coupling, 30-decibel transmission loss**15.3.6** Application: directional coupler showing coupling loss and directivity

First value is coupling loss; second value is directivity.

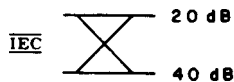

## 15.4 Hybrid Directionally Selective Transmission Devices

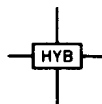
**15.4.1** Hybrid (general)**15.4.2** Hybrid, junction (magic T)

Commonly used in coaxial and waveguide transmission

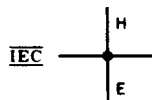

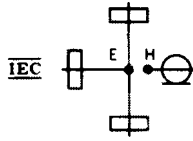
**15.4.3** Application: rectangular waveguide and coaxial coupling**15.4.4** Hybrid, circular (basic)

NOTE — 15.4.4A: The asterisk is not part of the symbol. Always replace the asterisk by E, H, or HE. E indicates there is a principal E transverse field in the plane of the ring. H indicates that there is a principal H transverse field in the plane of the ring. HE shall be used for all other cases.

An arm that has coupling of a different type from that designated above shall be marked according to COUPLING (item 15.2.1).

Critical distances should be labeled in terms of guide wavelengths.

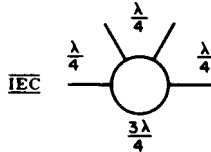

\* See Note 15.4.4A

**15.4.4.1** Application: 4-arm circular hybrid

**15.4.4.2** Application: rectangular waveguide circular hybrid with 3 arms coupling in the E plane and a fourth arm coupling in the H plane

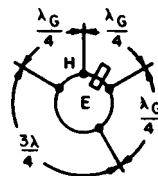
**15.5** Mode Transducer

Commonly used in coaxial and waveguide diagrams.

If it is desired to specify the type of transmission, appropriate indications may be added.

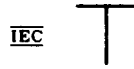
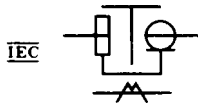
**15.5.1 General****15.5.2 Application: transition from rectangular to circular waveguide****15.5.3 Application: transition from rectangular waveguide to coaxial cable with mode suppression and direct-current grounds connected****15.6 Mode Suppressor**

Commonly used in coaxial and waveguide transmission.

**15.6.1 General****15.7 Rotary Joint (radio-frequency rotary coupler  $\boxplus$ )****15.7.1 General: with rectangular waveguide system**

NOTE — 15.7.1A: The asterisk is not part of the symbol. If necessary, a transmission path recognition symbol may be added. See symbol 3.6.

**15.7.1.1 Application: coaxial type in rectangular waveguide system**

**15.7.1.2** Application: circular waveguide type in rectangular waveguide system**15.8 Nonreciprocal Devices****15.8.1** Isolator

See also symbol 8.10

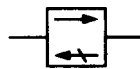
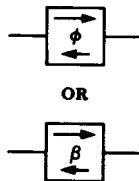
**15.8.2** Nonreciprocal directional phase shifter**15.8.3** Gyrotator

The longer arrow indicates the direction of propagation in which the required phase change occurs.

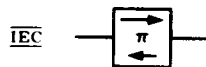
**15.8.4** Circulator, fixed direction

Arrowhead indicates direction of power flow from any input to next adjacent arm but not to any other arm. Circulator may have three or more ports.

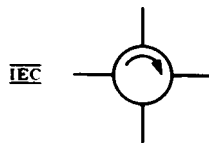
**15.8.4.1** Reversible direction

Current entering the coil at the end marked with the dot causes the energy in the circulator to flow in the direction of the arrowhead marked with the dot.

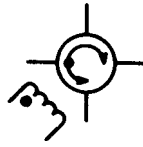

### 15.8.5 Field-polarization rotator

Arrow indicates direction of rotation of electric field when viewed in direction of signal flow.



### 15.8.6 Field-polarization amplitude modulator

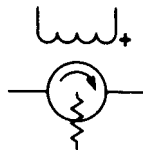

## 15.9 Resonator Tuned Cavity

Excluding piezoelectric and magnetostriction devices.

### 15.9.1 General

Commonly used for coaxial and waveguide transmission.

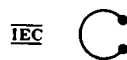

**15.9.2** Application: resonator with mode suppression coupled by an E-plane aperture to a guided transmission path and by a loop to a coaxial path

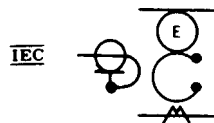

**15.9.3** Application: tunable resonator having adjustable Q coupled by a probe to a coaxial system

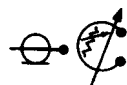

**15.9.4** Application: tunable resonator with direct-current ground connected to an electron device and adjustably coupled by an E-plane aperture to a rectangular waveguide

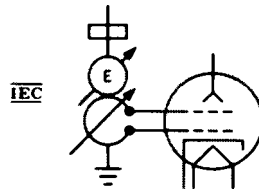

## 15.10 Resonator (cavity-type) Tube

**15.10.1** Single-cavity envelope and grid-type associated electrodes

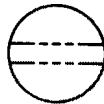

**15.10.2** Double-cavity envelope and grid-type associated electrodes

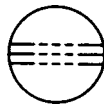

**15.10.3** Multicavity magnetron anode and envelope

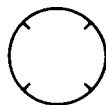

## 15.11 Magnetron

**15.11.1** Resonant type with coaxial output

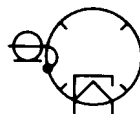

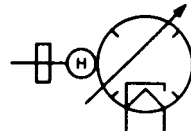
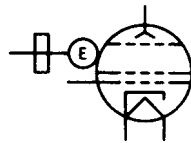
**15.11.2** Transit-time split-plate type with stabilizing deflecting electrodes and internal circuit**15.11.3** Tunable, aperture coupled**15.12 Velocity-Modulation (velocity-variation) Tube****15.12.1** Reflex klystron, integral cavity, aperture coupled**15.12.2** Double-cavity klystron, integral cavity, permanent externally ganged tuning, loop coupled (coupling loop may be shown inside if desired).

See symbol 15.2.2

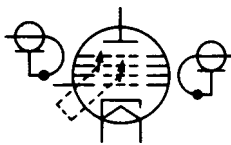
**15.13 Transmit-Receive (TR) Tube**

Gas-filled, tunable integral cavity, aperture coupled, with starter.

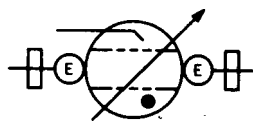

## 15.14 Traveling-Wave-Tube

**15.14.1** Forward-wave traveling-wave-tube amplifier shown with four grids, having slow-wave structure with attenuation, magnetic focusing by external permanent magnet, rf input and rf output coupling, each by E-plane aperture to external rectangular waveguide.

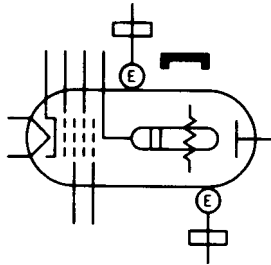

**15.14.2** Forward-wave traveling-wave-tube amplifier shown with four grids, having slow-wave structure with attenuation, magnetic focusing by external permanent magnet, rf input and rf output coupling, each by inductive coupling

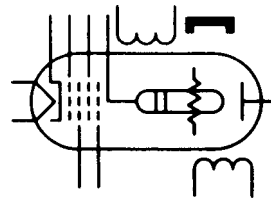

**15.14.3** Forward-wave traveling-wave-tube amplifier shown with four grids, having slow-wave structure with attenuation, external electromagnetic focusing, rf input and rf output coupling, even by external cavity and loop coupling to a coaxial path

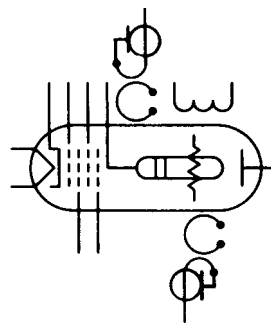



**15.14.4** Forward-wave traveling-wave-tube amplifier shown with four grids, having slow-wave structure with attenuation, magnetic focusing by external permanent magnet, rf input and rf output coupling, each by direct connection from slow-wave structure to a coaxial path

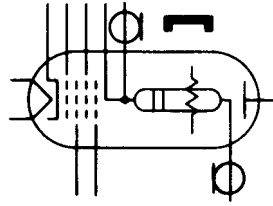

**15.14.5** Forward-wave traveling-wave-tube amplifier shown with four grids, having bifilar slow-wave structure with attenuation, electrostatic focusing, rf input and rf output coupling, each by inductive coupling

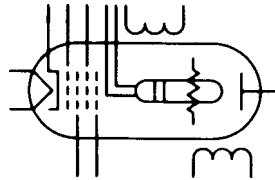

**15.14.6** Backward-wave traveling-wave-tube amplifier shown with two grids, having slow-wave structure with attenuation, sole (beam-aligning electrode), magnetic focusing by external permanent magnet, rf input and rf output coupling, each by E-plane aperture to external rectangular waveguide

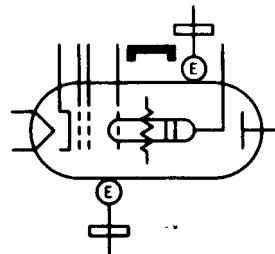

**15.14.7** Backward-wave traveling-wave-tube oscillator shown with two grids, having slow-wave structure with attenuation, sole (beam-aligning electrode), magnetic focusing by external permanent magnet, rf output coupling by inductive coupling

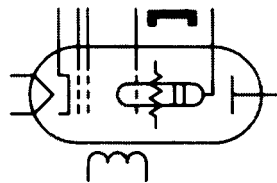

**15.14.8** Backward-wave traveling-wave-tube oscillator shown with two grids, having slow-wave structure with attenuation, sole (beam-aligning electrode), magnetic focusing by external permanent magnet, rf output coupling by inductive coupling, with slow-wave structure connected internally to collector

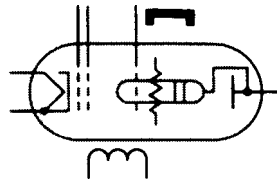

## 15.15 Balun

### 15.15.1 General

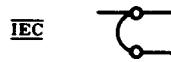

**15.15.2**<sup>26</sup> Application: balun connected between a balanced dipole and unbalanced coaxial cable

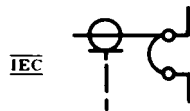

## 15.16 Filter

### 15.16.1 Mode filter

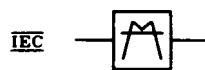

### 15.16.2 Frequency filter (bandpass)

See also symbol 16.1.1.2



## 15.17 Phase Shifter (matched)

See also symbols 15.8.2 and 16.6

<sup>26</sup>The broken line - - - indicates where line connection to a symbol is made and is not part of the symbol.

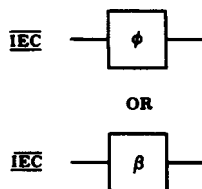

## 15.18 Ferrite Bead Ring

See also symbol 6.1.4

NOTE — 15.18A: If equivalent circuits must be shown within the symbol, the size or the aspect ratio of the original symbol may be altered providing its distinctive shape is retained.

### 15.18.1 General



### 15.18.2 Application: with equivalent circuit (LC network) shown



## 15.19 Line Stretcher (with female connectors shown)

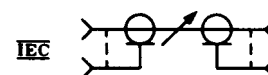

## Cross References

Bifilar Slow-Wave Structure (item 2.6.4)  
 Capacitive Termination (item 2.2.10)  
 Coaxial Cable, Recognition Symbol (item 3.1.9)  
 Inductive Termination (item 6.2.7)  
 Intentional Isolation of DC Path in Coaxial or Waveguide Applications (item 3.5)  
 Permanent Magnet (item 2.8)  
 Resistive Termination (item 2.1.11)  
 Shunt Capacitor (item 2.2.11)  
 Shunt Inductor (item 6.2.6)  
 Shunt Resistor (item 2.1.10)  
 Strip-Type Transmission Line (item 3.7)  
 Termination (item 3.8)  
 Waveguide (item 3.6)

## Waveguide Flanges (item 5.7)

## NOTES:

- 1 — See Introduction for general information (note especially A3.1).
- 2 — Symbols for single-line (one-line) diagrams appear at the left, symbols for complete diagrams at the right, and symbols suitable for both purposes are centered in each column.
- 3 — For centered figures with symbols appearing side by side, the symbol on the left-hand side should be considered to be for a single line (one-line) diagram and the symbol on the right-hand side for a complete diagram, i.e., 1.5.1.

## 16. Graphic Symbols for Composite Assemblies

### 16.1 Circuit Assembly

#### Circuit Subassembly

#### Circuit Element

## NOTES:

- 16.1A — The asterisk is not part of the symbol. Always indicate the type of apparatus by appropriate words or letters in the rectangle.
- 16.1B — If identification, electrical values, location data, and similar information must be noted within a symbol, the size or the aspect ratio of the original symbol may be altered providing its distinctive shape is retained.
- 16.1C — The use of a general circuit-element symbol is restricted to the following:
- a) Diagrams drawn in block form.
  - b) A substitute for complex circuit elements when the internal operation of the circuit element is not important to the purpose of the diagram.
  - c) Applications where a specific graphic symbol, or the parts to devise a suitable build-up, do not appear elsewhere in this standard.





#### 16.1.1 General



\* See Note 16.1A

**16.1.1.1** Accepted abbreviations from ANSI Z32.13-1950 may be used in the rectangle.

**16.1.1.2** The following letter combinations may be used in the rectangle:

CLK	Clock
EQ	Equalizer
FAX	Facsimile set 
FL	Filter
FL-BE	Filter, band-elimination
FL-BP	Filter, bandpass 
FL-HP	Filter, high-pass 
FL-LP	Filter, low-pass 
IND	Indicator
PS	Power supply 
RG	Recording unit

RU	Reproducing unit
ST-INV	Static inverter
DIAL	Telephone dial
TEL	Telephone station
TPR	Teleprinter $\square$
TTY	Teletypewriter $\square$

## 16.2 Amplifier

See also DIRECT-CURRENT MACHINES (symbols 13.4.20 to 13.4.23)

### 16.2.1 General

The triangle is pointed in the direction of transmission.

The symbol represents any method of amplification (electron tube, solid-state device, magnetic device, etc).

NOTE — 16.2.1A: If identification, electrical values, location data, and similar information must be noted within a symbol, the size or aspect ratio of the original symbol may be altered providing its distinctive shape is retained.

Amplifier use may be indicated in the triangle by words, standard abbreviations, or a letter combination from the following list:

BDG	Bridging
BST	Booster
CMP	Compression
DC	Direct-current
EXP	Expansion
LIM	Limiting
MON	Monitoring
PGM	Program
PRE	Preliminary
PWR	Power
TRQ	Torque



See Note 16.2.1A

### 16.2.2 Magnetic amplifier

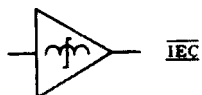

**16.2.3** Application: amplifier with two inputs

See Note 16.2.1A

**16.2.4** Application: amplifier with two outputs

See Note 16.2.1A

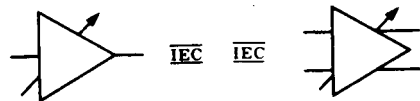
**16.2.5** Application: amplifier with adjustable gain

See Note 16.2.1A

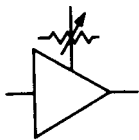
**16.2.6** Application: amplifier with associated attenuator

See Note 16.2.1A

**16.2.7** Application: amplifier with associated power supply

See Note 16.2.1A

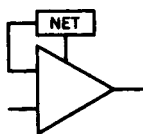
**16.2.8** Application: amplifier with external feedback path

See Note 16.2.1A

## 16.3 Rectifier

See ELECTRON TUBE (item 7.1), SEMICONDUCTOR DIODE (symbol 8.5.1), and SEMICONDUCTOR DEVICE (item 8.1)

### 16.3.1 General

NOTES:

16.3.1A — Triangle points in direction of forward (easy) current as indicated by a direct-current ammeter, unless otherwise noted adjacent to the symbol. Electron flow is in the opposite direction.

16.3.1B — This symbol represents any method of rectification (electron tube, solid-state device, electrochemical device, etc).



See Notes 16.3.1A and B

### 16.3.2 Controlled



See Notes 16.3.1A and B

### 16.3.3 Bridge-type rectifier

See item 8.5.1

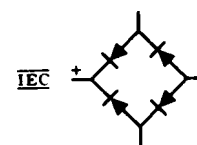

16.3.4 On connection or wiring diagrams, rectifier may be shown with terminals and polarity marking. Heavy line may be used to indicate nameplate or positive-polarity end.



For connection or wiring diagram

## 16.4 Repeater (includes Telephone Repeater )

### 16.4.1 1-way repeater

Triangle points in the direction of transmission.

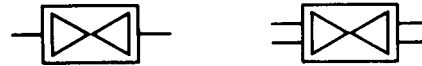
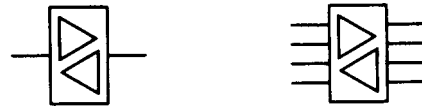
**16.4.2** 2-wire, 2-way repeater**16.4.3** 2-wire, 2-way repeater with low-frequency bypass**16.4.4** 4-wire, 2-way repeater

## 16.5 Network Artificial Line (other than delay line)

### 16.5.1 General

NET

### 16.5.2 Network, low-voltage power

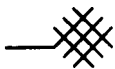

## 16.6 Phase Shifter Phase-Changing Network

For power circuits see ALTERNATING-CURRENT MACHINES (symbols 13.5.17 and 13.5.18)

See also symbol 15.17

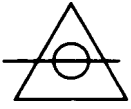

**16.6.1** General**16.6.2** 3-wire or 3-phase**16.6.3** Application: adjustable**16.6.4** Differential phase shifter

Phase shift  $\phi$  in direction of arrowhead; magnitudes shall be indicated.

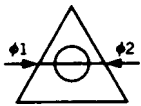
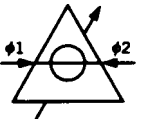
**16.6.5** Application: adjustable**16.7 Chopper** 

NOTES:

16.7A — The explanatory words are not part of the symbol.

16.7B — When diagram is other than single line, show connections as required for a specific device.

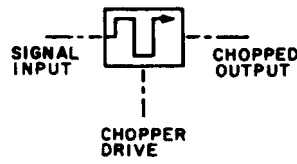

**16.8 Diode-Type Ring Demodulator  
Diode-Type Ring Modulator**

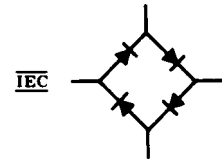

**16.9 Gyro  
Gyroscope  
Gyrocompass**



**16.10 Position Indicator**

**16.10.1 DC synchro type**



**16.10.2 Inductor type**



## 16.11 Position Transmitter

### 16.11.1 Desynn type (dc synchro type)

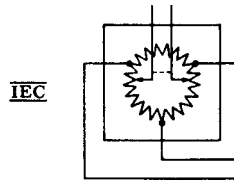

### 16.11.2 Inductor type

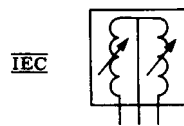

## 16.12 Fire Extinguisher Actuator Heads

### 16.12.1 Single head with connectors



### 16.12.2 Double head with connectors

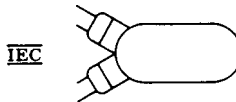

## Cross References

Oscillator (item 2.9)

### NOTES:

- 1 — See Introduction for general information (note especially A3.1).
- 2 — Symbols for single-line (one-line) diagrams appear at the left, symbols for complete diagrams at the right, and symbols suitable for both purposes are centered in each column.
- 3 — For centered figures with symbols appearing side by side, the symbol on the left-hand side should be considered to be for a single line (one-line) diagram and the symbol on the right-hand side for a complete diagram, i.e., 1.5.1.

## 17. Graphic Symbols for Analog and Digital Logic Functions

### 17.1 Operational Amplifier

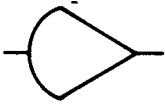

### 17.2 Summing Amplifier

(4 inputs and 1 output shown)

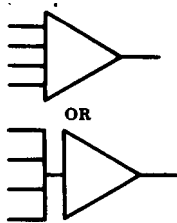

### 17.3 Integrator (Amplifier)

(4 inputs and 1 output shown)

NOTES:

17.3A — The asterisk is not part of the symbol. Always add identification within or adjacent to the circle.

17.3B — The letters IC mean Initial Conditions.

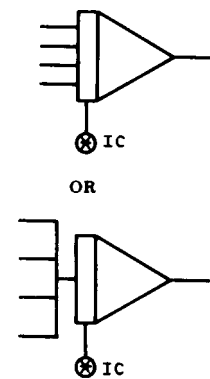

\* See Note 17.3A

## 17.4 Electronic Multiplier

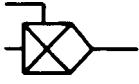

### 17.4.1 Two dependent multipliers

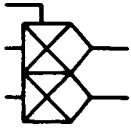

## 17.5 Electronic Divider

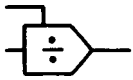

## 17.6 Electronic Function Generator

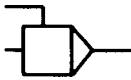

## 17.7 Generalized Integrator



## 17.8 Positional Servomechanism

Avoid conflict with item 2.6 if used on the same diagram.

NOTE — 17.8A: Dashed line indicates positioned in accordance with an input signal.



## 17.9 Function Potentiometer

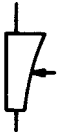

### Cross References

## 18. Graphic Symbols for Digital Logic Functions

### 18.1 Digital Logic Functions

(See cross references)

### Cross References

The following standards do not constitute a part of this standard; they are listed for reference purposes only:

American National Standard Graphic Symbols for Logic Diagrams (Two-State Devices), Y32.14-1973 (IEEE Std 91-1973)

NEMA Standard, Industrial Controls and Systems ICS-1970 with Revision 5, July 1975

### NOTES:

- 1 — See Introduction for general information (note especially A3.1).
- 2 — Symbols for single-line (one-line) diagrams appear at the left, symbols for complete diagrams at the right, and symbols suitable for both purposes are centered in each column.
- 3 — For centered figures with symbols appearing side by side, the symbol on the left-hand side should be considered to be for a single line (one-line) diagram and the symbol on the right-hand side for a complete diagram, i.e., 1.5.1.

## 19. Graphic Symbols for Special-Purpose Maintenance Diagrams

### 19.0 Introduction

The graphic symbols shown in this section were developed primarily for use on special-purpose maintenance diagrams, such as symbolic integrated maintenance-type diagrams, to provide detailed maintenance and operating information. See also item 23.1(3) for reference document. Use on other types of diagrams, however, is recommended if necessary to emphasize particular functions as defined in this section.<sup>27</sup>

See paragraph A4.5 of the Introduction

<sup>27</sup>The symbols shown in this section have comparable meanings or applications when used for drawings in mechanical, medical, or other disciplines or fields.

## 19.1 Data-Flow Code Signals

NOTE — 19.1A: Use only if essential to provide detailed maintenance and operation information (such as symbolic integrated maintenance manual diagrams).

### 19.1.1 Functional flow path

NOTE — 19.1.1A: Emphasis is required when it is necessary to differentiate between two relatively significant functional flow paths.

#### 19.1.1.1 Major (most significant)



#### 19.1.1.2 Minor (least significant)



### 19.1.2 Signal code

NOTE — 19.1.2A: All signal-code symbols shall be drawn on the functional flow path lines, e.g.,



#### 19.1.2.1 Normal

NOTE — 19.1.2.1A: The asterisk is not part of the symbol. Add an identification code letter when necessary for clarity.



\*See Note 19.1.2.1A

##### 19.1.2.1.1 Application: emergency mode



##### 19.1.2.1.2 Application: automatic mode



#### 19.1.2.2 Secondary flow; power distribution



**19.1.2.3** Reference signal voltage; reference frequency**19.1.2.4** Signal to energize relay**19.1.2.5** Transmitter pulse; pulse-forming network, discharge path, or subsequent high-level modulation pulse

NOTE — 19.1.2.5A: This symbol shall be used only on a major (most significant) functional flow path.

**19.1.2.6** Gating; synchronizing signal; low-level modulating signal

NOTE — 19.1.2.6A: This symbol shall be used only on a minor (least significant) functional flow path.

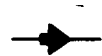
**19.1.2.7** Test signal; signal used to light a lamp or provide a meter reading**19.1.2.8** Feedback

NOTE — 19.1.2.8A: The arrowheads shall be placed close together.

**19.1.3** Fault-signal code

NOTE — 19.1.3A: All fault signals shall use the signal-code symbols shown in items 19.1.2 through 19.1.2.6, except that they are not to be filled in.

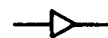
**19.1.3.1** Application: fault-isolation signal to relay



## 19.2 Functional Circuits

See Note 19.1A

### 19.2.1 Amplifier circuit (such as voltage amplifier, power amplifier etc.)

NOTES:

19.2.1A — This symbol represents an active circuit (of one or more stages) which changes the voltage or power level of the incoming signal, and contains one or more non-linear active elements, such as an electron tube, transistor, or diode.

19.2.1B — The asterisk is not part of the symbol. A circuit identifier code should be added for proper identification of the basic symbol.

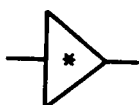

\*See Note 19.2.1B

### 19.2.2 Signal generator; signal processor

NOTE — 19.2.2A: This symbol represents an active circuit (of one or more stages) which generates a signal or processes an incoming signal in a manner other than to change the signal voltage or power level, e.g., oscillator, multivibrator, mixer, etc. Such circuits contain one or more active elements, such as an electron tube, transistor, or diode.

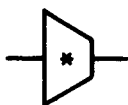

\*See Note 19.2.1B

### 19.2.3 Linear element; linear network

NOTE — 19.2.3A: This symbol represents a resistor, a capacitor, or a network consisting of any combination of these linear elements, such as a filter network, voltage divider, pulse-forming network, etc.

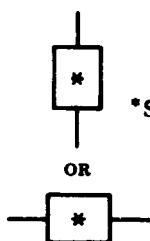

\*See Note 19.2.1B

### 19.2.4 Relay contacts



\*See Note 19.2.1B

**19.2.5 Relay coil or operating coil**

\*See Note 19.2.1B

**19.2.6 Switch**

\*See Note 19.2.1B

**19.2.7 Digital logic elements**

See Section 18

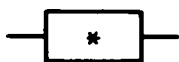
**19.2.8 Composite circuit (other than those covered by symbols 19.2.1 through 19.2.6)**

\*See Note 19.2.1B

**Cross References**

## NOTES:

- 1 — See Introduction for general information (note especially A3.1).
- 2 — Symbols for single-line (one-line) diagrams appear at the left, symbols for complete diagrams at the right, and symbols suitable for both purposes are centered in each column.
- 3 — For centered figures with symbols appearing side by side, the symbol on the left-hand side should be considered to be for a single line (one-line) diagram and the symbol on the right-hand side for a complete diagram, i.e., 1.5.1.

**20. Graphic Symbols Commonly Used on System Diagrams, Maps, and Charts****20.1 Radio Station**

Other antenna symbols may be used to indicate specific types.

NOTE — 20.1A: The asterisk is not part of the symbol; identification of the type of station may be added within or adjacent to the symbol.

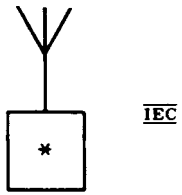
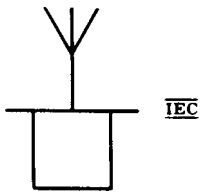
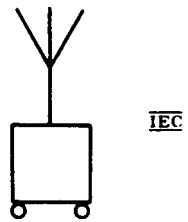
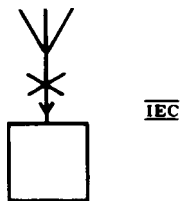
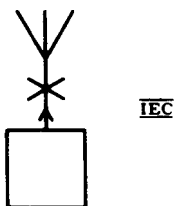
**20.1.1** General**20.1.2** Portable**20.1.3** Mobile**20.1.4** Direction-finding**20.1.5** Radio beacon

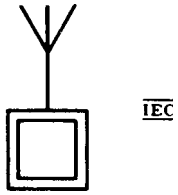
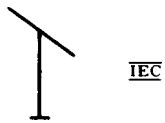
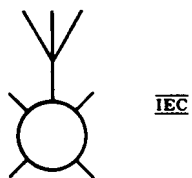
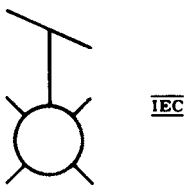
**20.1.6 Controlling****20.1.7 Passive relay****20.2 Space Station****20.2.1 General****20.2.2 Active space station****20.2.3 Passive space station**

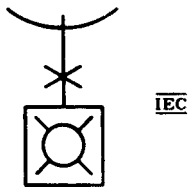
**20.2.4** Earth station used for tracking a space station (shown with a paraboloidal antenna)**20.2.5**

Application: earth station of a communication service via space station

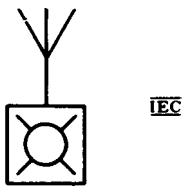
**20.3 Exchange Equipment****20.3.1** General

NOTE — 20.3.1A: The asterisk is not part of the symbol. Replace the asterisk with information to specify a particular application.

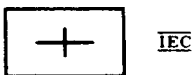

\* See Note 20.3.1A

**20.3.2** Automatic switching**20.3.3** Manual switchboard**20.4 Telegraph Repeater**

The letter "T" may be omitted if no confusion will result.

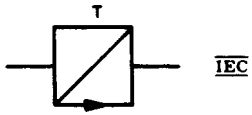
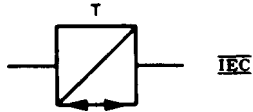
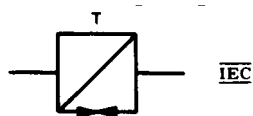
**20.4.1** One-way simplex operation**20.4.2** Two-way simplex operation**20.4.3** Duplex operation**20.4.4** Qualifying symbols

The following symbols are restricted to use with the symbols in item 20.4 of this standard.

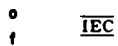
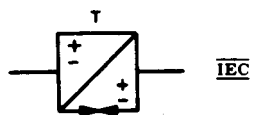
**20.4.4.1** Polar direct-current (double current)**20.4.4.2** Neutral direct-current (single current)**20.4.4.3** Alternating-current**20.4.5** Applications:**20.4.5.1** Polar direct-current for duplex operation

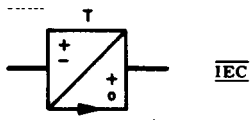
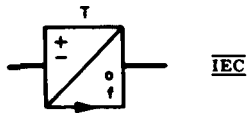
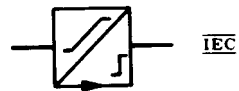
**20.4.5.2** Polar direct-current/neutral direct-current for one-way simplex operation**20.4.5.3** Polar direct-current/alternating-current for one-way simplex operation**20.4.5.4** Regenerative type for one-way simplex operation**20.5 Telegraph Equipment****20.5.1** General

NOTE — 20.5.1A: The letter “T” may be replaced by a suitable qualifying symbol from item 20.5.6.

**20.5.2** Transmitter**20.5.3** Receiver

**20.5.4** Two-way simplex**20.5.5** Duplex**20.5.6** Qualifying symbols

The following symbols are restricted to use with the symbols in Section 20.5 of this standard.

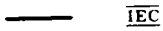
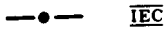
**20.5.6.1** Tape printing**20.5.6.2** Tape perforating; perforated tape**20.5.6.3** Simultaneous printing on and perforating of one tape**20.5.6.4** Page printing**20.5.6.5** Keyboard**20.5.6.6** Facsimile

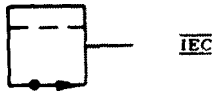
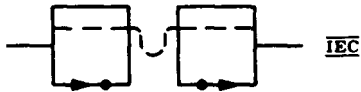

**20.5.7 Applications:****20.5.7.1 Tape-printing receiver****20.5.7.2 Tape-printing receiver with keyboard transmitter****20.5.7.3 Printing reperforator****20.5.7.4 Page-printing receiver****20.5.7.5 Page-printing receiver with keyboard transmitter****20.5.7.6 Facsimile receiver****20.5.7.7 Keyboard perforator**

**20.5.7.8** Automatic transmitter using perforated tape**20.5.7.9** Separate reperforator and automatic transmitter with continuous tape feed**20.6 Telephone Set****20.6.1** General**20.6.2** Local-battery**20.6.3** Common-battery**20.6.4** Dial-type

NOTE — 20.6.4A: The dots may be omitted if no confusion would result.

**20.6.5** Pushbutton dialing

**20.6.6** With two or more extension lines**20.6.7** With coin box**20.6.8** With ringing generator**20.6.9** Loudspeaker-type**20.6.10** Amplifier-type**20.6.11** Sound-powered**20.6.12** Key or pushbutton type with special facilities (other than dialing or multiline operation)

## Cross References

### NOTES:

- 1 — See Introduction for general information (note especially A3.1).
- 2 — Symbols for single-line (one-line) diagrams appear at the left, symbols for complete diagrams at the right, and symbols suitable for both purposes are centered in each column.
- 3 — For centered figures with symbols appearing side by side, the symbol on the left-hand side should be considered to be for a single line (one-line) diagram and the symbol on the right-hand side for a complete diagram, i.e., 1.5.1.

## 21. Graphic Symbols Commonly Used on System Diagrams, Maps, and Charts

### 21.1 Generating Station

#### NOTES:

- 21.1A — Symbols for “planned” applications appear on the left; symbols for “in service” applications appear on the right.
- 21.1B — The preferred symbol is the square, but if necessary, a rectangle may be used.
- 21.1C — Relative sizes of symbols are shown. Symbol size may be reduced for small-size diagrams. See also paragraph A4.5 of the Introduction.

#### 21.1.1 General

See note 21.1A



### 21.2 Hydroelectric Generating Station

See Note 21.1A

#### 21.2.1 General



#### 21.2.2 Run of river

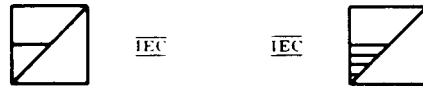
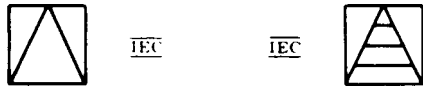

**21.2.3 With storage****21.2.4 With pumped storage****21.3 Thermoelectric Generating Station**

See Note 21.1A

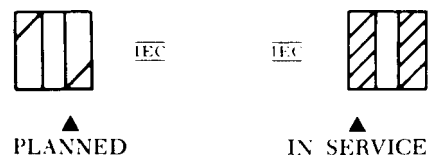
**21.3.1 General****21.3.2 Coal or lignite fueled****21.3.3 Oil or gas fueled****21.3.4 Nuclear energy fueled**

### 21.3.5 Geothermic

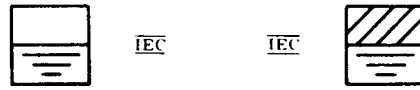

### 21.4 Prime Mover (qualifying symbols)

Use if essential to show the type of prime mover in a generating station.

See Note 21.1A

#### 21.4.1 Gas turbine



21.4.1.1 Application: shown for oil- or gas-fueled generating station



#### 21.4.2 Reciprocating engine



21.4.2.1 Application: shown for oil- or gas-fueled generating station



### 21.5 Substation

See Note 21.1A

#### 21.5.1 General

Avoid conflict with symbol 13.1.1 if used on the same diagram.

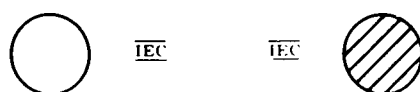

### 21.5.2 Rectifier substation

Use if essential to show type of equipment.

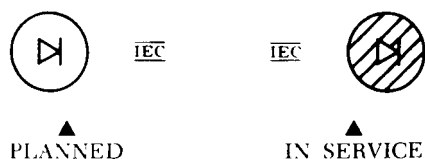

## Cross References

### NOTES:

- 1 — See Introduction for general information (note especially A3.1).
- 2 — Symbols for single-line (one-line) diagrams appear at the left, symbols for complete diagrams at the right, and symbols suitable for both purposes are centered in each column.
- 3 — For centered figures with symbols appearing side by side, the symbol on the left-hand side should be considered to be for a single line (one-line) diagram and the symbol on the right-hand side for a complete diagram, i.e., 1.5.1.

## 22. Class Designation Letters<sup>28</sup>

for use in assignment of reference designations for electrical and electronics parts and equipments as described in ANSI Y32.16-1975, Reference Designations for Electrical and Electronics Parts and Equipments

### 22.1 Class Designation Letter

The letters identifying the class of an item shall be selected in accordance with the list in paragraph 22.4.

For reference purposes, see also alphabetical listings of the items and other common and colloquial names in the index.

Graphic symbols do not appear in this standard for H, HP, N, WT, and some MP (listed in paragraph 22.4) because they apply to items beyond the scope of this standard.

Certain item names and designating letters may apply to either a part or an assembly.

### 22.2 Special Considerations for Class Designation Letter Assignment

#### 22.2.1 Actual versus intended function

If a part serves a purpose other than its generally intended one, the function actually performed shall be represented by the graphic symbol used on the schematic diagram; the class letter shall be chosen from the list in paragraph 22.4 and shall be indicative of its physical characteristics. For example, a semiconductor diode used as a fuse would be

<sup>28</sup>Device function designations for power switchgear, industrial control, and industrial equipment use are not covered by this standard. For typical application of these device function designations, see:

- a) American national Standard Manual and Automatic Station Control, Supervisory, and Associated Telemetering Equipments, C37.2-1970.
- b) NEMA Standard, Industrial Controls and Systems ICS-1970 (R1975).
- c) Joint Industrial Council Electrical Standards for Mass Production Equipment, EMP-1-1967, and General Purpose Machine Tools, EGP-1-1967.
- d) Military Standard, Designations for Electric Power Switchgear Devices and Industrial Control Devices, MIL-STD-27.

represented by the graphic symbol for a fuse (actual function), but the class letter would be D or CR (class of part). If a part has a dual function, the class letter for the principal physical characteristic of the part shall apply.

### **22.2.2 Assembly versus subassembly**

The term subassembly as used herein shall apply equally to an assembly.

### **22.2.3 Subassembly versus individual part**

A group of parts shall not be treated as a subassembly unless it is one or more of the following:

- a) A plug-in item.
- b) A significant item covered by a separate schematic.
- c) A multiapplication item.
- d) Likely to be handled as a replaceable item for maintenance purposes.

### **22.2.4 Specific versus general**

The letters A and U (for assembly) shall not be used if more specific class letters are listed in paragraph 22.4 for a particular item.

### **22.2.5 Inseparable subassemblies**

Potted, embedded, riveted, or hermetically sealed subassemblies, modular assemblies, printed circuit boards, and integrated circuit packages and similar items which are ordinarily replaced as a single item of supply shall be treated as parts. They shall be assigned the class letter U, unless a more specific class letter is applicable.

## **22.3 Item Names**

In the alphabetically arranged class letter list of paragraph 22.4, item names approved in the Federal Item Identification Guide, Cataloging Handbook H6-1, as of the date of this edition (though additional modifiers may be necessary), are indicated by the symbol  $\square$ . For definitions which are not contained in Handbook H6-1, see American National Standard C42.100.





## **22.4 Class Designation Letters: Alphabetical List**

Parts not specifically included in this list shall be assigned a letter or letters from the list below for the part or class most similar in function.





















Designations for general classes of parts are marked with an asterisk (\*) to facilitate designation of parts not specifically included in this standard.















A <sup>*†</sup> (see also U and 22.2.4)	<ul style="list-style-type: none"> <li>electronic divider</li> <li>electronic function generator (other than rotating)</li> <li>electronic multiplier</li> <li>facsimile set <math>\square</math></li> <li>field-polarization amplitude modulator</li> <li>field-polarization rotator</li> <li>general circuit element</li> <li>gyroscope</li> <li>integrator</li> <li>positional servomechanism</li> <li>sensor (transducer to electric power)</li> <li>separable assembly<sup>‡</sup></li> <li>separable subassembly</li> <li>telephone set</li> <li>telephone station</li> <li>teleprinter <math>\square</math></li> <li>teletypewriter <math>\square</math></li> </ul>
AR	<ul style="list-style-type: none"> <li>amplifier (other than rotating)</li> <li>repeater</li> </ul>
AT	<ul style="list-style-type: none"> <li>bolometer</li> <li>capacitive termination</li> <li>fixed attenuator <math>\square</math></li> <li>inductive termination</li> <li>isolator (nonreciprocal device)</li> <li>pad</li> <li>resistive termination</li> </ul>
B	<ul style="list-style-type: none"> <li>blower</li> <li>motor <math>\square</math></li> <li>synchro <math>\square</math></li> </ul>
BT	<ul style="list-style-type: none"> <li>barrier photocell</li> <li>battery <math>\square</math></li> <li>battery cell</li> <li>blocking layer cell</li> <li>photovoltaic transducer</li> <li>solar cell</li> </ul>
C	<ul style="list-style-type: none"> <li>capacitor bushing</li> <li>capacitor <math>\square</math></li> </ul>
CB	<ul style="list-style-type: none"> <li>circuit breaker <math>\square</math></li> <li>network protector</li> </ul>
CP	<ul style="list-style-type: none"> <li>connector adapter <math>\square</math></li> <li>coupling (aperture, loop, or probe)</li> <li>junction (coaxial or waveguide)</li> </ul>

D or CR	asymmetrical varistor crystal diode current regulator (semiconductor device) diode (semiconductor type) diode rectifier (semiconductor type) diode-type ring demodulator diode-type ring modulator metallic rectifier  photodiode (photosensitive type) stabistor thyristor (semiconductor diode type) varactor
D or VR	breakdown diode (voltage regulator) overvoltage absorber 
DC	directional coupler
DL	delay function delay line  slow-wave structure
DS	alphanumeric display device annunciator electrically restored drop general light source indicator (excluding meter or thermometer)  lamp (excluding heating lamp) light-emitting solid-state device manually restored drop photodiode (photoemissive type) signal light visual alarm visual indicator visual signaling device

E*	aluminum cell antenna armature binding post $\square$ cable termination carbon block circuit terminal conductivity cell electrical contact $\square$ electrical contact brush $\square$ electrical shield electrolytic cell ferrite bead rings film element gap (horn, protective, or sphere) Hall element ignitor gap insulator $\square$ lightning arrester $\square$ magnetic core miscellaneous electrical part optical shield permanent magnet $\square$ rotary joint (microwave) short circuit (termination) spark gap splice telephone protector $\square$ telephone protector block $\square$ terminal (individual) $\square$ valve element vibrating reed
EQ	equalizer equalizing network
F	current limiter (for power cable) fuse $\square$ fuse cutout
FL	filter $\square$
G	electronic chopper $\square$ generator $\square$ ignition magneto $\square$ interrupter vibrator $\square$ oscillator rotating amplifier (regulating generator) telephone magneto
H*	hardware (common fasteners, etc)
HP*	hydraulic part
HR	heater $\square$ heating lamp heating resistor infrared lamp $\square$ thermomechanical transducer
HS	handset $\square$ operator's set

HT	earphone  electrical headset  receiver (excluding radio receiver) telephone receiver
HY	circulator directionally selective transmission device hybrid circuit network  hybrid coil (telephone usage) hybrid junction (magic T)
J	disconnecting device (receptacle connector) electrical receptacle connector  jack receptacle (connector, stationary portion) waveguide flange (choke) 
K	contactor (magnetically operated) relay 
L	coil (all not classified as transformers)  electrical solenoid  field winding generator field inductor lamp ballast motor field reactor  winding 
LS	audible alarm audible signaling device buzzer  electric bell  electric horn  loudspeaker  loudspeaker-microphone siren  telephone ringer  telephone sounder  underwater sound transducer
M	clock  coulomb accumulator elapsed time recorder electric timer electrical counter  electrochemical step-function device instrument message register meter meter-type level pressure gage oscillograph  oscilloscope  position indicator thermometer

MG	converter (rotating machine) dynamotor $\square$ inverter (motor-generator) motor-generator $\square$
MK	hydrophone microphone $\square$ telephone transmitter
MP*	brake clutch mechanical interlock mechanical part miscellaneous mechanical part (bearing, coupling, gear, shaft)
MT	accelerometer measuring transducer mode transducer motional pickup transducer primary detector
N**	equipment subdivision
P	disconnecting device (plug connector) electrical plug connector $\square$ plug (connector, movable portion) waveguide flange (plain) $\square$
PS	power supply $\square$ rectifier (complete power-supply assembly)
PU	head (with various modifiers) sound reproducer $\square$
Q	semiconductor controlled rectifier semiconductor controlled switch phototransistor (3 terminal) thyatron (semiconductor device) thyatron (semiconductor triode type) transistor $\square$
R	function potentiometer instrument shunt magnetoresistor potentiometer relay shunt resistor $\square$ rheostat $\square$
RE	radio receiver $\square$
RT	ballast lamp ballast tube current-regulating resistor $\square$ resistance lamp temperature-sensing element thermal resistor $\square$ thermistor
RV	symmetrical varistor voltage-sensitive resistor $\square$

S	<p>contactor (manually, mechanically, or thermally operated)</p> <p>disconnecting device (switch)</p> <p>electrical safety interlock</p> <p>flasher (circuit interrupter)</p> <p>governor (electrical contact type) </p> <p>speed regulator (electrical contact type)</p> <p>switch </p> <p>telegraph key</p> <p>telephone dial </p> <p>thermal cutout (circuit interrupter) (not visual)</p> <p>thermostat</p>
SQ	<p>electric squib </p> <p>explosive squib</p> <p>fusible link</p> <p>igniter squib</p> <p>sensing link</p>
SR	<p>electrical contact ring </p> <p>rotating contact</p> <p>slip ring</p>
T	<p>autotransformer</p> <p>coaxial taper</p> <p>linear coupler</p> <p>telephone induction coil </p> <p>telephone repeating coil </p> <p>transformer </p> <p>waveguide taper</p>
TB	<p>connecting strip</p> <p>terminal board </p> <p>terminal strip</p> <p>test block</p>
TC	<p>semiconductor thermocouple</p> <p>thermocouple </p> <p>thermopile</p>
TP <sup>††</sup>	test point
TR	radio transmitter 
U* <sup>†</sup> (see also A* and 22.2.4)	<p>inseparable assembly</p> <p>integrated-circuit package</p> <p>microcircuit</p> <p>micromodule</p> <p>photon-coupled isolator</p>
V	<p>electron tube </p> <p>Geiger-Muller counter tube</p> <p>ionization chamber</p> <p>klystron</p> <p>magnetron</p> <p>phototube</p> <p>proportional counter tube</p> <p>resonator tube (cavity type)</p> <p>solion</p> <p>thyatron (electron tube)</p> <p>traveling-wave tube</p> <p>voltage regulator (electron tube)</p>

VR (see also D)	induction voltage regulator voltage regulator (excluding electron tube) $\square$
W	bus bar $\square$ cable cable assembly (with connectors) coaxial cable conductor distribution line distribution path Goubau line strip-type transmission line transmission line transmission path waveguide $\square$ wire $\square$
WT <sup>‡‡</sup>	wiring tiepoint
X	fuseholder $\square$ lampholder $\square$ socket $\square$
Y	magnetostriction oscillator piezoelectric crystal unit quartz crystal unit $\square$ tuning-fork resonator $\square$
Z	artificial line (other than delay line) balun carrier-line trap coupled tunable resonator directional phase shifter (non- reciprocal) discontinuity (usually coaxial or waveguide transmission use) E-H tuner general network (where specific class letters do not fit) gyrator mode suppressor multistub tuner phase shifter phase-changing network $\square$ resonator (tuned cavity) slide-screw tuner

\*Device function designations for power switchgear, industrial control, and industrial equipment use are not covered by this standard. For typical application of these device function designations, see:

American National Standard Manual and Automatic Station Control, Supervisory, and Associated Telemetering Equipments, C37.2-1970.

NEMA Standard, Industrial Controls and Systems ICS-1970 (R1975).

Joint Industrial Council Electrical Standards for Mass Production Equipment, EMP-1-1967, and General Purpose Machine Tools, EGP-1-1967.

Military Standard, Designations for Electric Power Switchgear Devices and Industrial Control Devices, MIL-STD-27.

†The class letter A is assigned on the basis that the item is separable. The class letter U shall be used if the item is inseparable.

‡For economic reasons, assemblies which are fundamentally separable may not be so provisioned but may be supplied as complete assemblies. However, the class letter A shall be retained.

\*\*Not a class letter, but used to identify a subdivision of an equipment in the Location Numbering Method.

‡‡Not a class letter, but commonly used to designate test points for maintenance purposes. See American National Standard Y14.15-1966 (R1973).

‡‡Not a class letter, but commonly used to designate a tiepoint on connection diagrams. See American National Standard Y14.15-1966 (R1973).

## 22.5 Item Names: Alphabetical List

The index to this standard shows the class designation letter as applicable under the general rules, together with the item number of the representative graphic symbol.

## 22.6 Item Designations, IEC 113-2

For reference purposes, Appendix F shows a comparison of the class letters used to identify parts and equipment according to International Electrotechnical Commission (IEC) Publication 113-2 and those assigned in American National Standard Y32.2-1975.

## 23. Referenced Standards and Canadian Standard Z99 Modifications

### 23.1 Referenced Standards <sup>29</sup>

When the following American National Standards are superseded by a revision approved by the American National Standards Institute, the revision shall apply:

American National Standard Reference Designations for Electrical and Electronics Parts and Equipment, Y32.16-1975 (IEEE Std 200-1975 ) (1)

American National Standard Graphic Symbols for Logic Diagrams, Y32.14-1973 (IEEE Std 91-1973 ) (1)

American National Standard Drafting Practices (Electrical and Electronics Diagrams), Y14.15-1966 (R1973) and Supplements Y14.15a-1970 (R1973) and Y14.15b-1973.

American National Standard Abbreviations for Use on Drawings, Y1.1-1972 (2)

American National Standard Manual and Automatic Station Control, Supervisory, and Associated Telemetering Equipments, C37.2-1970 (2)

American National Standard Dimensions of Caps, Plugs, and Receptacles, C73.10-1966 (R1972) through C73.44-1966 (R1972)

American National Standard Dictionary of Electrical and Electronics Terms, C42.100-1972 (IEEE Std 100-1972)

<sup>29</sup>For Military Applications:

- (1) Refer to the latest edition adopted for mandatory use by the Department of Defense.
- (2) Refer to the following military standards (latest edition at time of invitation to bid) in lieu of the American National Standards:  
ANSI C37.2-1970 (in part): use MIL-STD-27 Designations for Electric Power Switchgear Devices and Industrial Control Devices.  
ANSI Y1.1-1972: use MIL-STD-12 Abbreviations for Use on Drawings, Specifications, Standards, and in Technical Documents.
- (3) The following documents are listed for purposes of information only:  
MIL-STD-100 Engineering Drawing Practices.  
MIL-M-24100 Manuals, Technicals: Functionally Oriented Maintenance Manual (FOMM)  
Federal Cataloging Handbook H6-1, Section A.



## 100. Canadian Standard Z99 Modifications to American National Standard Y32.2-1975 (IEEE Std 315-1975)

While not illustrated in the Standard itself, the widespread practice of using heavier lines in drawing certain symbols can, if followed, result in improved drawing readability. The practice is consistent with Clause A4.3. It is therefore recommended that heavier lines be used to show:

- 1.10 Envelopes
- 2.2 Capacitors
- 2.5 The negative plates of batteries and cells
- 4.3 The parallel lines in the (4.29 and 4.30) parallel contact symbols
- 4.7 The moving contact in the push button symbol
- 7.1 Indirectly heated cathode, anode and combinations including these
- 8.5 Base symbol as used for semiconductors

These items are illustrated below:

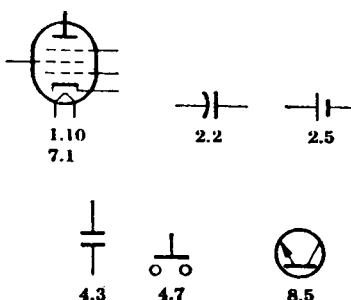

Additionally, it is recommended that the last symbol of Section 3.1.6.3 be avoided in all cases. Where space is at a premium, the possibility of misreading it as a crossover will usually be greater.

**DO NOT USE**



### Cross References

For Graphical Electrical Symbols for Architectural Plans see Appendix F of CSA Standard C22.1-1975.

**Annex A****Cross Reference List of Changed Item Numbers****(Informative)**

(These appendixes are not part of American National Standard Graphic Symbols for Electrical and Electronics Diagrams (Including Reference Designation Class Designation Letters) Y32.2-1975 (IEEE Std 315-1975), but are included to facilitate its use.)

<b>ANSI Y32.2-1970</b>	<b>ANSI Y32.2-1975</b>	<b>ANSI Y32.2-1970</b>	<b>ANSI Y32.2-1975</b>
1.3.1.1	1.3.1	2.2.14	2.2.13
1.3.1.2	1.3.1	2.2.15	2.2.14
1.3.2.1	1.3.2	2.2.16	2.2.15
1.3.2.2	1.3.2	2.2.17	2.2.16
1.3.3	1.3.2	2.3.6.8	14.2.4.1
1.3.3.1	1.3.2	2.6.1 (top)	2.6.4
1.3.3.2	1.3.2	2.6.3	2.6.4
2.2.9	2.2.11	4.2.1.1 (bottom)	4.2.1.2
2.2.11	2.2.12	4.2.1.2	4.2.1.1
2.2.12	2.2.9	4.2.1.3	4.2.1.2
2.2.13	2.2.9.1	4.2.1.4	4.2.1.3

## Annex B

### Reference Data

#### International Electrotechnical Commission (IEC)

#### Publication 117: Recommended Graphical Symbols

#### (Informative)

The following documents were used for the listing of the IEC symbols (IEC) next to those graphic symbols in this standard that are considered to be in accordance with the graphic symbols in Publication 117.

##### Publication 117

##### Part No.



0	General Index (1973)
1	Kind of current, distribution systems, methods of connection and circuit elements (1960) Amendments: 1 (August 1966), 2 (August 1967), 3 (August 1973)
2	Machines, transformers, primary cells, and accumulators, transducers and magnetic amplifiers, inductors (1960) Amendments: 1 (August 1966), 2 (October 1971), 3 (August 1973) Supplement A (April 1974)
3	Contacts, switchgear, mechanical controls, starters, and elements of electromechanical relays (1963) Amendments: 1 (August 1966), 2 (March 1972), 3 (August 1973), 4 (May 1974) Supplements: A (April 1970), Second (1972)
4	Indicating instruments and electric clocks (1963) Amendments: 1 (October 1971), 2 August 1973), 3 (May 1974)
5	Generating stations and substations, lines for transmission and distribution (1963) Amendment 1 (August 1973)
6	Variability, examples of resistors, elements of electronic tubes, values and rectifiers (1964) Amendments: 1 (August 1966), 2 (December 1967), 3 (August 1973)
7	Semiconductor devices, capacitors (Second edition, 1971)
8	Architectural diagrams (1967)
9	Telephony, telegraphy, and transducers (1968) Supplements: First (1969), B (April 1971)

- 10 Aerials (antennas) and radio stations (1968)  
Supplement A (Nov 1969)
- 11 Microwave technology (1968)  
First supplement (1971)
- 12 Frequency spectrum diagrams (1968)
- 13 Block symbols for transmission and  
miscellaneous applications (1969)  
Supplements: First (1971), Second (1972), C  
(April 1974)
- 14 Telecommunication lines and accessories  
(1971)  
Supplement A (May 1974)
- 15 Binary logic elements (1972)
- 16 Ferrite Cores and magnetic storage matrices  
(1972)

## Annex C

### Revised or Deleted Symbols



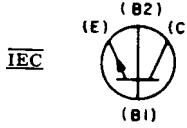
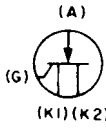
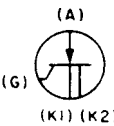





(Informative)

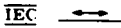









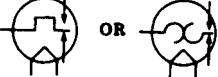

Symbols Formerly in ANSI Y32.2-1970	Recommended Symbols in ANSI Y32.2-1975
Revised 2.6.3 Bifilar slow-wave structure Commonly used in traveling-wave tubes.  *See Note 2.6.1A	See item 2.6.4
Deleted Alternate 8.5.1 Semiconductor diode; semiconductor rectifier diode; metallic rectifier  OR	See item 8.5.1
Revised Alternate 8.5.2 Capacitive diode (varactor) Style 2 	See item 8.5.2 Style 2
Deleted Alternate 8.6.3 NPN transistor with transverse-biased base  <u>IEC</u>	See item 8.6.3
Revised 8.11 <b>Solid-State Thyratron (replacement type)</b> 8.11.1 Balanced  8.11.2 Unbalanced 	See item 8.11.1  See item 8.11.2





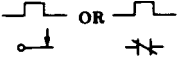

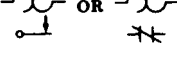
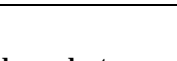
## Annex D

### Revised or Deleted Symbols

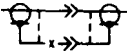

#### (Informative)





Symbols Formerly in USAS Y32.2-1967	Recommended Symbols in ANSI Y32.2- 1975, if Not Otherwise Specified
Modified <b>1.7.2 Both ways</b>   <b>OR</b>  <b>See Note 1.7.1A</b>	See item 1.7.2
Expanded <b>2.1.12 Thermistor</b> <b>Thermal resistor</b>  <b>2.1.12.1 General</b>   <b>2.1.12.2 With independent integral heater</b>  	See item 2.1.12
Revised <b>2.8 Permanent Magnet</b> 	See item 2.8
Revised <b>3.1.9* Coaxial cable, recognition symbol</b> <b>Coaxial transmission path</b> <b>Radio-frequency cable</b>  (coaxial)  NOTE — 3.1.9A: If necessary for clarity, an outer-conductor connection to the symbol shall be made where the broken line - - - is shown.   <b>See Note 3.1.9A</b>	See item 3.1.9

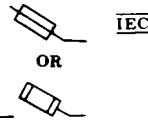
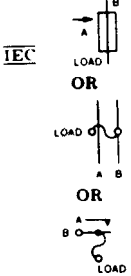



Symbols Formerly in USAS Y32.2-1967	Recommended Symbols in ANSI Y32.2- 1975, if Not Otherwise Specified
<p>Revised and Expanded</p> <p><b>4.21 Thermostat</b> Ambient-temperature-operated device. Operates on rising temperature.</p> <p><b>4.21.1 With break contact</b> See also item 4.20.2</p>  <p style="text-align: center;">OR</p> <p><b>4.21.2 With make contact</b> See also item 4.20.2</p>  <p style="text-align: center;">OR</p> <p><b>4.21.3 With integral heater and transfer contacts</b></p>  <p style="text-align: center;">OR</p> 	<p>See items 4.21 through 4.21.7</p>
<p>Deleted</p> <p><b>4.30 Relay</b> </p> <p> †FO <b>Fast-operate</b></p> <p> †FR <b>Fast-release</b></p>	<p>See item 4.30</p>
<p>Revised and Expanded</p> <p><b>4.30.5 Thermal relay</b> </p>  <p style="text-align: center;">OR</p>  <p style="text-align: center;">OR</p>  <p style="text-align: center;">OR</p> 	<p>See items 4.30.5 through 4.30.6</p>
<p>Revised</p> <p><b>5.6.2 Coaxial with the outside conductor shown carried through</b></p> 	<p>See item 5.6.2</p>

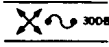
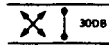

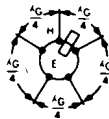
<p style="text-align: center;">Symbols Formerly in USAS Y32.2-1967</p>	<p style="text-align: center;">Recommended Symbols in ANSI Y32.2- 1975, if Not Otherwise Specified</p>
<p>Revised</p> <p><b>5.6.3 Application: Coaxial with outside conductor shown carried through; with outside conductor terminated on chassis</b></p> 	<p>See item 5.6.3</p>
<p>Revised</p> <p><b>5.6.4 Application: Coaxial with center conductor shown carried through; outside conductor not carried through</b></p> 	<p>See item 5.6.4</p>
<p>Revised</p> <p><b>5.7.1 Mated (general)</b></p>  <p>See Note 5.7A</p>	<p>See item 5.7.1</p>
<p>Deleted</p> <p><b>5.7.4 Application: mated choke flanges in rectangular waveguide line</b></p> 	<p>See item 5.7.4</p>
<p>Revised</p> <p><b>5.7.5 Application: rectangular waveguide with mated plain and choke flanges with direct-current isolation (insulation) between sections of waveguide.</b></p> 	<p>See item 5.7.5</p>
<p>Revised</p> <p><b>7.3.6 Cathode-ray tube</b> <b>7.3.6.1 With electric-field deflection</b></p>  <p><b>7.3.6.2 For magnetic deflection</b></p> 	<p>See items 7.3.6 through 7.3.6.2.2</p>

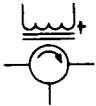

Symbols Formerly in USAS Y32.2-1967	Recommended Symbols in ANSI Y32.2- 1975, if Not Otherwise Specified
Revised <b>8.6.15 Thyristor, bidirectional triodetype; triac; gated switch</b>  Style 3 	See item 8.6.15
Revised and Expanded <b>9.1.2 High-voltage primary fuse cut-out, dry</b>  	See item 9.1.3
Revised and Expanded <b>9.1.4 With alarm contact</b>  When fuse blows, alarm bus A is connected to power bus B. Letters are for explanation and are not part of the symbol. 	See item 9.1.2
Revised <b>10.4.1 General</b>  	See item 10.4.1
Revised <b>15.2.4 Coupling by loop from coaxial to circular waveguide with direct-current grounds connected</b>  	See item 15.2.4





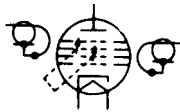
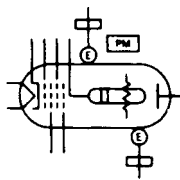

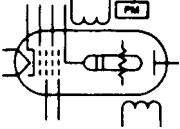
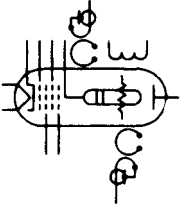
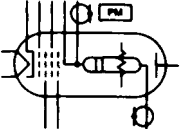

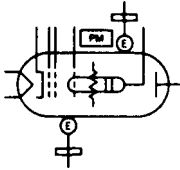
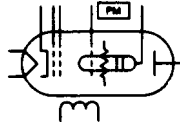
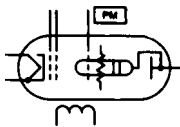





















<p style="text-align: center;"><b>Symbols Formerly in USAS Y32.2-1967</b></p>	<p style="text-align: center;"><b>Recommended Symbols in ANSI Y32.2- 1975, if Not Otherwise Specified</b></p>
<p>Revised</p> <p><b>15.2.7 Coupling by probe from coaxial to rectangular waveguide with direct-current grounds connected</b></p> 	<p>See item 15.2.7</p>
<p>Revised</p> <p><b>15.3.2 Application: E-plane aperture coupling, 30-decibel transmission loss</b></p>  <p><b>15.3.3 Application: loop coupling, 30-decibel transmission loss</b></p>  <p><b>15.3.4 Application: probe coupling, 30-decibel transmission loss</b></p>  <p><b>15.3.5 Application: resistance coupling, 30-decibel transmission loss</b></p> 	<p>See items 15.3.2 through 15.3.6</p>
<p>Revised</p> <p><b>15.4.4.1 Application: 5-arm circular hybrid with principal coupling in the E plane and with 1-arm H coupling using rectangular waveguide</b></p> 	<p>See item 15.4.4</p>

Symbols Formerly in USAS Y32.2-1967	Recommended Symbols in ANSI Y32.2- 1975, if Not Otherwise Specified
<p>Deleted</p> <p><b>15.4.5.1 Application: circulator, reversible direction</b></p> <p>The polarity symbol (item 1.6) must be used with electromagnet symbol to indicate proper direction flow.</p> 	<p>See item 15.8.4.1</p>
<p>Revised</p> <p><b>15.5.3 Application: transducer from rectangular waveguide to coaxial with mode suppression and direct-current grounds connected.</b></p> 	<p>See item 15.5.3</p>
<p>Revised</p> <p><b>15.7.1.1 Application: coaxial type in rectangular waveguide system</b></p> 	<p>See item 15.7.1.1</p>
<p>Deleted</p> <p><b>15.8.3 Unidirectional (isolator) Power flowing in direction of arrow is not intentionally attenuated.</b></p> 	<p>See item 15.8.1</p>
<p>Revised</p> <p><b>15.9.2 Application: resonator with mode suppression coupled by an E-plane aperture to a guided transmission path and by a loop to a coaxial path</b></p> 	<p>See item 15.9.2</p>

<p style="text-align: center;">Symbols Formerly in USAS Y32.2-1967</p>	<p style="text-align: center;">Recommended Symbols in ANSI Y32.2- 1975, if Not Otherwise Specified</p>
<p>Revised</p> <p><b>15.9.3 Application: tunable resonator having adjustable Q coupled by a probe to a coaxial system</b></p> 	<p>See item 15.9.3</p>
<p>Revised</p> <p><b>15.11.1 Resonant type with coaxial output</b></p> 	<p>See item 15.11.1</p>
<p>Revised</p> <p><b>15.12.2 Double-cavity klystron, integral cavity, permanent externally-ganged tuning, loop coupled (coupling loop may be shown inside if desired) See item 7.1.7.1.</b></p> 	<p>See item 15.12.2</p>
<p>Revised</p> <p><b>15.14.1 Forward-wave traveling-wave-tube amplifier shown with four grids, having slow-wave structure with attenuation, magnetic focusing by external permanent magnet, rf input and rf output coupling, each by E-plane aperture to external rectangular waveguide</b></p> 	<p>See item 15.14.1</p>

Symbols Formerly in USAS Y32.2-1967	Recommended Symbols in ANSI Y32.2- 1975, if Not Otherwise Specified
<p>Revised</p> <p><b>15.14.2 Forward-wave traveling-wave-tube amplifier shown with four grids, having slow-wave structure with attenuation, magnetic focusing by external permanent magnet, rf input and rf output coupling, each by inductive coupling</b></p> 	<p>See item 15.14.2</p>
<p>Revised</p> <p><b>15.14.3 Forward-wave traveling-wave-tube amplifier shown with four grids, having slow-wave structure with attenuation, external electromagnetic focusing rf input and rf output coupling—each by external cavity and loop coupling, to a coaxial path</b></p> 	<p>See item 15.14.3</p>
<p>Revised</p> <p><b>15.14.4 Forward-wave traveling-wave-tube amplifier shown with four grids, having slow-wave structure with attenuation, magnetic focusing by external permanent magnet, rf input and rf output coupling, each by direct connection from slow-wave structure to a coaxial path</b></p> 	<p>See item 15.14.4</p>

Symbols Formerly in USAS Y32.2-1967	Recommended Symbols in ANSI Y32.2- 1975, if Not Otherwise Specified
<p>Revised</p> <p>15.14.6 Backward-wave traveling-wave-tube amplifier shown with two grids, having slow-wave structure with attenuation, sole (beam-aligning electrode), magnetic focusing by external permanent magnet, rf input and rf output coupling, each by E-plane aperture to external rectangular waveguide</p> 	See item 15.14.6
<p>Revised</p> <p><b>15.14.7 Backward-wave traveling-wave-tube oscillator shown with two grids, having slow-wave structure with attenuation, sole (beam-aligning electrode), magnetic focusing by external permanent magnet, rf output coupling by inductive coupling</b></p> 	See item 15.14.7
<p>Revised</p> <p><b>15.14.8 Backward-wave traveling-wave-tube oscillator shown with two grids, having slow-wave structure with attenuation, sole (beam-aligning electrode), magnetic focusing by external permanent magnet, rf output coupling by inductive coupling, with slow-wave structure connected internally to collector</b></p> 	See item 15.14.8

Symbols Formerly in USAS Y32.2-1967	Recommended Symbols in ANSI Y32.2- 1975, if Not Otherwise Specified																																																									
<p>Deleted</p> <p>16.1.1.3 Additional letter combinations, as follows, may be employed, but the use of specific graphic symbols included elsewhere in this standard is preferred</p> <table> <tr><td>AR</td><td>Amplifier</td><td></td></tr> <tr><td>AT</td><td>Attenuator</td><td></td></tr> <tr><td>C</td><td>Capacitor</td><td></td></tr> <tr><td>CB</td><td>Circuit breaker</td><td></td></tr> <tr><td>HS</td><td>Handset</td><td></td></tr> <tr><td>I</td><td>Indicating or switchboard lamp</td><td></td></tr> <tr><td>L</td><td>Inductor</td><td></td></tr> <tr><td>J</td><td>Jack</td><td></td></tr> <tr><td>LS</td><td>Loudspeaker</td><td></td></tr> <tr><td>MIC</td><td>Microphone</td><td></td></tr> <tr><td>OSC</td><td>Oscillator</td><td></td></tr> <tr><td>PAD</td><td>Pad</td><td></td></tr> <tr><td>P</td><td>Plug</td><td></td></tr> <tr><td>HT</td><td>Receiver, headset</td><td></td></tr> <tr><td>K</td><td>Relay</td><td></td></tr> <tr><td>R</td><td>Resistor</td><td></td></tr> <tr><td>S</td><td>Switch</td><td> or key switch</td></tr> <tr><td>T</td><td>Transformer</td><td></td></tr> <tr><td>WR</td><td>Wall receptacle</td><td></td></tr> </table>	AR	Amplifier		AT	Attenuator		C	Capacitor		CB	Circuit breaker		HS	Handset		I	Indicating or switchboard lamp		L	Inductor		J	Jack		LS	Loudspeaker		MIC	Microphone		OSC	Oscillator		PAD	Pad		P	Plug		HT	Receiver, headset		K	Relay		R	Resistor		S	Switch	 or key switch	T	Transformer		WR	Wall receptacle		See item 16.1.1
AR	Amplifier																																																									
AT	Attenuator																																																									
C	Capacitor																																																									
CB	Circuit breaker																																																									
HS	Handset																																																									
I	Indicating or switchboard lamp																																																									
L	Inductor																																																									
J	Jack																																																									
LS	Loudspeaker																																																									
MIC	Microphone																																																									
OSC	Oscillator																																																									
PAD	Pad																																																									
P	Plug																																																									
HT	Receiver, headset																																																									
K	Relay																																																									
R	Resistor																																																									
S	Switch	 or key switch																																																								
T	Transformer																																																									
WR	Wall receptacle																																																									

\*The broken line - — - indicates where line connection to a symbol is made and is not part of the symbol.



## Annex E

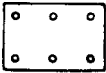
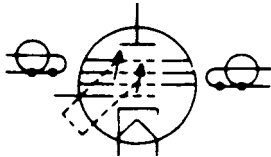
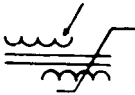

### Revised or Deleted Symbols

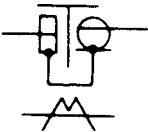

(Informative)

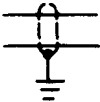
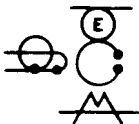
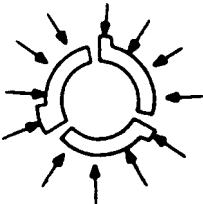



Symbols Formerly in USA Standard Y32.2-1962 & Supplement Y32.2A-1964 or MIL-STD-15-1A (including original item numbers)	Recommended Symbols in ANSI Y32.2 - 1975, if Not Otherwise Specified
<p>Deleted</p> <p><b>11.3.1</b> On a connection or wiring diagram, a 3-pole single-throw circuit breaker (with terminals shown) may be drawn as shown below</p>  <p><b>See Note 11.3A FOR CONNECTION OR WIRING DIAGRAM</b></p>	See ANSI Y14.15-1966
<p>Corrected</p> <p><b>34.11.10.2</b> Double-cavity klystron, integral cavity, permanent external-ganged tuning, loop coupled (coupling loop may be shown inside if desired) See item 34.8.1</p> 	See item 15.12.2
<p>Revised and Expanded</p> <p><b>42.7</b> Saturable-core inductor (reactor) Polarity marks may be added to direct-current winding. Explanatory words and arrow are not part of the symbols shown.</p> 	See item 6.3
<p>Revised</p> <p><b>48 Meter Instrument</b> T                      Temperature meter</p>	See item 12.1

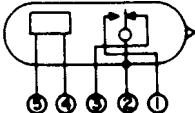
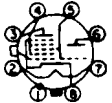

<b>Symbols Formerly in USA Standard Y32.2-1962 &amp; Supplement Y32.2A-1964 or MIL-STD-15-1A (including original item numbers)</b>	<b>Recommended Symbols in ANSI Y32.2 - 1975, if Not Otherwise Specified</b>
<p>Corrected  <b>53.3</b> Application: transducer from rectangular waveguide to coaxial with mode suppression and direct-current grounds connected</p> 	<p>See item 15.5.3</p>
<p>Corrected  <b>58.8.2</b> Coaxial cable, recognition sym-  Coaxial transmission path  Cable, radio frequency <math>\square</math>, (Coaxial) See item 58.1.</p> 	<p>See item 3.1.9</p>
<p>Corrected  <b>58.8.4</b> Shielded 2-conductor cable with shield grounded</p> 	<p>See item 3.1.8.4</p>
<p>Corrected  <b>71.2.1</b> Resonator with mode suppression coupled by an E-plane aperture to a guided transmission path and by a loop to a coaxial path.</p> 	<p>See item 15.9.2</p>
<p>Revised  <b>76.12.7</b> Wafer, 3-pole 3-circuit with 2 nonshorting and 1 shorting moving contacts  Viewed from end opposite control knob or actuator unless otherwise indicated.  For more than one section, section No. 1 is nearest control knob.  When contacts are on both sides, front contacts are nearest control knob.</p> 	<p>See item 4.13.7</p>

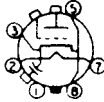
Symbols Formerly in USA Standard Y32.2-1962 & Supplement Y32.2A-1964 or MIL-STD-15-1A (including original item numbers)	Recommended Symbols in ANSI Y32.2 - 1975, if Not Otherwise Specified
<p>Deleted</p> <p><b>81.5 Applications</b></p> <p>NOTES:</p> <p>81.5A — If the device terminals are in a circular arrangement, the actual angular spacing between the terminals should be approximated on the terminal diagram.</p> <p>81.5B — If the terminals are in an essentially linear arrangement the terminal diagram may show the terminals in either a linear array along one side of the elongated envelope symbol (preferable), or within a maximum angle of 150 degrees around the circular envelope symbol.</p> <p>81.5C — If pins are omitted in an otherwise standard terminal arrangement, do not respace the remaining pins.</p> <p>81.5D — A terminal at the center of the terminal arrangement shall be identified as the CENTER terminal lead or pin.</p> <p>81.5E — The typical examples show pin numbering in accordance with standard industry practice, i.e., with the terminals viewed from outside the terminal face of the device.</p> <p><b>81.5.1</b> Two-terminal device with one flexible lead and one rigid terminal connected to a metallic envelope (typical semiconductor diode shown).</p>  <p><b>81.5.2</b> Two-terminal device with rigid terminals and reference point located at one of the terminals (typical semiconductor diode shown).</p>  <p><b>81.5.3</b> Three-terminal device with circular arrangement of pin terminals with base orientation determined by gap in pin spacing (typical transistor shown).</p> 	<p>See ANSI Y14.15-1966</p>

Symbols Formerly in USA Standard Y32.2-1962 & Supplement Y32.2A-1964 or MIL-STD-15-1A (including original item numbers)	Recommended Symbols in ANSI Y32.2 - 1975, if Not Otherwise Specified
<p>Deleted (continued)</p> <p><b>81.5.4</b> Three-terminal device with rigid terminals, one connected to the metallic enclosure, and index pin (typical transistor shown).</p>  <p><b>81.5.5</b> Four-terminal device with in-line pin terminals, one connected to metallic envelope, and reference point (typical transistor shown).</p>  <p>OR</p>  <p><b>81.5.6</b> Five-terminal device with in-line terminal leads, one connected to metallic enclosure and reference point (typical relay shown).</p>  <p><b>81.5.7</b> Device with 8-terminal keyed (such as octal) base, rigid envelope terminal, and magnetic envelope connected to base terminal (typical triode-heptode shown).</p> 	<p>See ANSI Y14.15-1966</p>

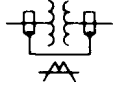
<p><b>Symbols Formerly in USA Standard Y32.2-1962 &amp; Supplement Y32.2A-1964 or MIL-STD-15-1A (including original item numbers)</b></p>	<p><b>Recommended Symbols in ANSI Y32.2 - 1975, if Not Otherwise Specified</b></p>
<p>Deleted (continued)</p> <p><b>81.5.8</b> Device with keyed (such as octal) base having design capability of 8 pins but with 2 pins omitted, and with 3 rigid envelope terminals (typical disc-seal triode shown).</p>  <p><b>81.5.9</b> Device with 9-terminal (such as noval) base utilizing gap in pin spacing to establish base orientation (typical twin triode shown).</p> 	
<p>Revised</p> <p><b>84 Thermistor Resistor, Thermal</b> </p> <p>“T” indicates that the primary characteristic of the element within the circle is a function of temperature.</p>	<p>See items 1.2.1 and 2.1.12</p>
<p>Revised</p> <p><b>84.1</b> General</p> 	<p>See item 2.1.12.1</p>
<p>Revised</p> <p><b>85.2.1</b> Temperature-measuring semiconductor thermocouple</p> 	<p>See item 8.8.1</p>
<p>Corrected</p> <p><b>86.1.1</b> Application: transformer with direct-current connections and mode suppression between two rectangular waveguides</p> 	<p>See item 6.4.1.1</p>

## Annex F

### Cross-Reference List of Class Designation Letters

#### (Informative)

IEC Publication 113-2 (1971) Item Designations, Letter Codes

ANSI Y32.2-1975 (IEEE Std 315-1975), Section 22, Class Designation Letters

- \* No conflict between ANSI Y32.2 and IEC.
- # ANSI Y32.2 not in agreement with IEC, but no conflict if used.
- @ ANSI Y32.2 conflicts with IEC as IEC uses class letter to represent other devices.

	IEC Publication 113-2 Terminology	Letter Code	
		IEC	Y32.2
#	Acoustical indicator	H	LS
*	Adjustable resistor	R	R
@	Aerial	W	E
#	Amplifier	A	AR
#	Amplifier (with tubes)	A	AR
@	Arrester	F	E
*	Assemblies	A	A,U
*	Auxiliary switch	S	S
#	Battery	G	BT
#	Bistable element	D	U,A
#	Brake	Y	MP
*	Busbar	W	W
*	Cable	W	W
*	Cable balancing network	Z	Z
*	Capacitor	C	C
#	Changer	U	A,B,G,MT
#	Circuit breaker	Q	CB
#	Clutch	Y	MP
*	Coder	U	U,A
#	Compander	Z	A
*	Connecting stage	S	S
*	Contactors	K	K
*	Control switch	S	S
*	Converter	U	A,U,MG
@	Core, storage	D	E

<b>IEC Publication 113-2</b>		<b>Letter Code</b>	
<b>Terminology</b>	<b>IEC</b>	<b>Y32.2</b>	
# Crystal filter	Z	FL	
@ Crystal transducer	B	Y	
* Current transformer	T	T	
# Delay device	D	DL	
# Delay line	D	DL	
# Demodulator	U	A	
* Dial contact	S	S	
@ Diode	V	D	
@ Dipole	W	E	
@ Disconnecting plug	X	P	
* Disconnecting socket	X	X	
# Discriminator	U	A	
# Disk recorder	D	A	
# Dynamotor	B	MG	
# Electrically operated mechanical device	Y	MT	
* Electronic tube	V	V	
# Equalizer	Z	EQ	
# Filter	Z	FL	
# Frequency changer	U	A,B,G	
* Fuse	F	F	
* Gas discharge tube	V	V	
* Generator	G	G	
# Heating device	E	HR	
* Hybrid	Z	Z	
# Indicating device	P	DS	
* Induction coil	L	L	
* Inductors	L	L	
# Integrating measuring device	P	M,MT,Z	
# Inverter	U	A,U,PS,MG	
# Isolator	Q	AT	
* Jumper wire	W	W	
# Laser	A	MT,A	
# Lighting device	E	DS	
* Limit switch	S	S	

IEC Publication 113-2		Letter Code	
	Terminology	IEC	Y32.2
#	Limiter	Z	MT,RE
@	Line trap	L	FL,MP,V
#	Loudspeaker	B	LS
#	Magnetic amplifier	A	AR
#	Magnetic tape recorder	D	A
*	Maser	A	A
@	Measuring equipment	P	M
#	Microphone	B	MK
*	Miscellaneous	E	E
#	Modulator	U	A
#	Monostable element	D	A,U
@	Motor	M	B
#	Optical indicator	H	DS
@	Oscillator	G	Y,G
*	Overvoltage discharge device	F	F,E
@	Parabolic aerial	W	E
@	Photoelectric cell	B	V
#	Pickup	B	PU
@	Plug	X	P
#	Pneumatic valve	Y	MP
*	Potentiometer	R	R
@	Power switchgear	Q	CB,S
*	Protective device	F	F
*	Pushbutton	S	S
@	Quartz-oscillator	G	Y
#	Recording device	P	A,M
#	Register	D	A,U,M
*	Relay	K	K
*	Resistor	R	R
*	Resolver	B	B
*	Rheostat	R	R
*	Rotating frequency generator	G	G,MG
*	Rotating generator	G	G
*	Selector	S	S

<b>IEC Publication 113-2</b>		<b>Letter Code</b>	
<b>Terminology</b>	<b>IEC</b>	<b>Y32.2</b>	
* Selector switch	S	S	
#, @ Semiconductor	V	D,CR,Q	
* Shunt (resistor)	R	R	
# Signal generator	P	A	
# Signaling device	H	DS	
* Socket	X	X	
# Soldering terminal strip	X	E,TB	
# Static frequency changer	U	A	
# Storage device	D	A,U	
* Subassembly	A	A	
# Supply	G	A,PS	
# Supply device	G	A,PS	
* Sychro	B	B	
# Telegraph translator	U	A	
@ Terminal	X	E	
# Terminal board	X	TB	
# Termination	Z	AT	
# Test jack	X	E,J	
# Testing equipment	P	A	
# Thermistor	R	RT	
# Thermo cell	B	A,TC	
# Thermoelectric sensor	B	A	
# Thyristor	V	Q	
# Transducer (nonelectrical quantity to electrical quantity)	B	A,BT	
* Transformer	T	T	
* Transmission path	W	W	
@ Transistor	V	Q	
* Tube (electron)	V	V	
* Voltage transformer (potential)	T	T	
* Waveguide	W	W	
# Waveguide directional coupler	W	DC	