

Digital Circuits: Part 4



M. B. Patil

mbpatil@ee.iitb.ac.in

www.ee.iitb.ac.in/~sequel

Department of Electrical Engineering
Indian Institute of Technology Bombay

- * The digital circuits we have seen so far (gates, multiplexer, demultiplexer, encoders, decoders) are *combinatorial* in nature, i.e., the output(s) depends only on the *present* values of the inputs and *not* on their past values.

- * The digital circuits we have seen so far (gates, multiplexer, demultiplexer, encoders, decoders) are *combinatorial* in nature, i.e., the output(s) depends only on the *present* values of the inputs and *not* on their past values.
- * In *sequential* circuits, the “state” of the circuit is crucial in determining the output values. For a given input combination, a sequential circuit may produce different output values, depending on its previous state.

- * The digital circuits we have seen so far (gates, multiplexer, demultiplexer, encoders, decoders) are *combinatorial* in nature, i.e., the output(s) depends only on the *present* values of the inputs and *not* on their past values.
- * In *sequential* circuits, the “state” of the circuit is crucial in determining the output values. For a given input combination, a sequential circuit may produce different output values, depending on its previous state.
- * In other words, a sequential circuit has a *memory* (of its past state) whereas a combinatorial circuit has no memory.

- * The digital circuits we have seen so far (gates, multiplexer, demultiplexer, encoders, decoders) are *combinatorial* in nature, i.e., the output(s) depends only on the *present* values of the inputs and *not* on their past values.
- * In *sequential* circuits, the “state” of the circuit is crucial in determining the output values. For a given input combination, a sequential circuit may produce different output values, depending on its previous state.
- * In other words, a sequential circuit has a *memory* (of its past state) whereas a combinatorial circuit has no memory.
- * Sequential circuits (together with combinatorial circuits) make it possible to build several useful applications, such as counters, registers, arithmetic/logic unit (ALU), all the way to microprocessors.

NAND latch (RS latch)

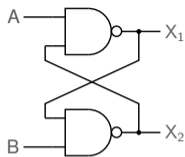

A	B	X ₁	X ₂
1	0		
0	1		
1	1		
0	0		

* A, B: inputs, X₁, X₂: outputs

NAND latch (RS latch)

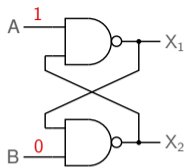

A	B	X ₁	X ₂
1	0		
0	1		
1	1		
0	0		

- * A, B : inputs, X_1, X_2 : outputs
- * Consider $A = 1, B = 0$.

NAND latch (RS latch)

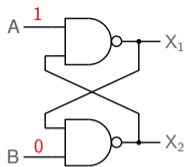

A	B	X ₁	X ₂
1	0		
0	1		
1	1		
0	0		

- * A, B : inputs, X_1, X_2 : outputs
- * Consider $A = 1, B = 0$.
 $B = 0 \Rightarrow X_2 = 1$

NAND latch (RS latch)

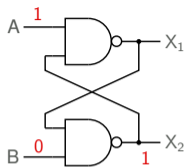

A	B	X ₁	X ₂
1	0		
0	1		
1	1		
0	0		

- * A, B : inputs, X_1, X_2 : outputs
- * Consider $A = 1, B = 0$.
 $B = 0 \Rightarrow X_2 = 1$

NAND latch (RS latch)

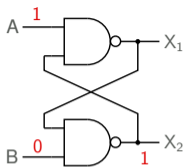

A	B	X ₁	X ₂
1	0		
0	1		
1	1		
0	0		

* A, B : inputs, X_1, X_2 : outputs

* Consider $A = 1, B = 0$.

$$B = 0 \Rightarrow X_2 = 1 \Rightarrow X_1 = \overline{AX_2} = \overline{1 \cdot 1} = 0.$$

NAND latch (RS latch)

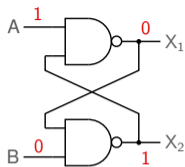

A	B	X ₁	X ₂
1	0		
0	1		
1	1		
0	0		

* A, B : inputs, X_1, X_2 : outputs

* Consider $A = 1, B = 0$.

$$B = 0 \Rightarrow X_2 = 1 \Rightarrow X_1 = \overline{AX_2} = \overline{1 \cdot 1} = 0.$$

NAND latch (RS latch)

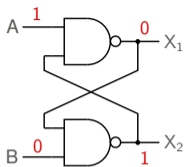

A	B	X ₁	X ₂
1	0	0	1
0	1		
1	1		
0	0		

* A, B : inputs, X_1, X_2 : outputs

* Consider $A = 1, B = 0$.

$$B = 0 \Rightarrow X_2 = 1 \Rightarrow X_1 = \overline{AX_2} = \overline{1 \cdot 1} = 0.$$

Overall, we have $X_1 = 0, X_2 = 1$.

NAND latch (RS latch)

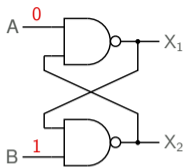

A	B	X ₁	X ₂
1	0	0	1
0	1		
1	1		
0	0		

- * A, B : inputs, X_1, X_2 : outputs
- * Consider $A = 1, B = 0$.
 $B = 0 \Rightarrow X_2 = 1 \Rightarrow X_1 = \overline{AX_2} = \overline{1 \cdot 1} = 0$.
Overall, we have $X_1 = 0, X_2 = 1$.
- * Consider $A = 0, B = 1$.

NAND latch (RS latch)

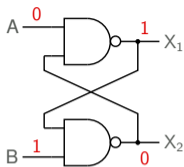

A	B	X ₁	X ₂
1	0	0	1
0	1	1	0
1	1		
0	0		

- * A, B : inputs, X_1, X_2 : outputs
- * Consider $A = 1, B = 0$.
 $B = 0 \Rightarrow X_2 = 1 \Rightarrow X_1 = \overline{AX_2} = \overline{1 \cdot 1} = 0$.
Overall, we have $X_1 = 0, X_2 = 1$.
- * Consider $A = 0, B = 1$.
 $\rightarrow X_1 = 1, X_2 = 0$.

NAND latch (RS latch)

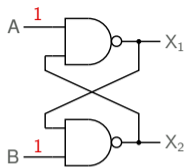

A	B	X ₁	X ₂
1	0	0	1
0	1	1	0
1	1		
0	0		

- * A, B : inputs, X_1, X_2 : outputs
- * Consider $A = 1, B = 0$.
 $B = 0 \Rightarrow X_2 = 1 \Rightarrow X_1 = \overline{AX_2} = \overline{1 \cdot 1} = 0$.
Overall, we have $X_1 = 0, X_2 = 1$.
- * Consider $A = 0, B = 1$.
 $\rightarrow X_1 = 1, X_2 = 0$.
- * Consider $A = B = 1$.

NAND latch (RS latch)

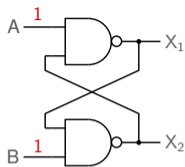

A	B	X ₁	X ₂
1	0	0	1
0	1	1	0
1	1		
0	0		

* A, B: inputs, X₁, X₂: outputs

* Consider A = 1, B = 0.

$$B = 0 \Rightarrow X_2 = 1 \Rightarrow X_1 = \overline{A X_2} = \overline{1 \cdot 1} = 0.$$

Overall, we have X₁ = 0, X₂ = 1.

* Consider A = 0, B = 1.

$$\rightarrow X_1 = 1, X_2 = 0.$$

* Consider A = B = 1.

$$X_1 = \overline{A X_2} = \overline{X_2}, X_2 = \overline{B X_1} = \overline{X_1} \Rightarrow \boxed{X_1 = \overline{X_2}}$$

NAND latch (RS latch)

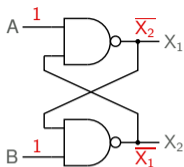

A	B	X ₁	X ₂
1	0	0	1
0	1	1	0
1	1	previous	
0	0		

* A, B : inputs, X_1, X_2 : outputs

* Consider $A = 1, B = 0$.

$$B = 0 \Rightarrow X_2 = 1 \Rightarrow X_1 = \overline{A X_2} = \overline{1 \cdot 1} = 0.$$

Overall, we have $X_1 = 0, X_2 = 1$.

* Consider $A = 0, B = 1$.

$$\rightarrow X_1 = 1, X_2 = 0.$$

* Consider $A = B = 1$.

$$X_1 = \overline{A X_2} = \overline{X_2}, X_2 = \overline{B X_1} = \overline{X_1} \Rightarrow \boxed{X_1 = \overline{X_2}}$$

NAND latch (RS latch)

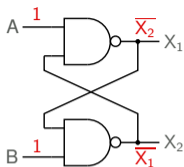

A	B	X ₁	X ₂
1	0	0	1
0	1	1	0
1	1	previous	
0	0		

* A, B : inputs, X_1, X_2 : outputs

* Consider $A = 1, B = 0$.

$$B = 0 \Rightarrow X_2 = 1 \Rightarrow X_1 = \overline{A X_2} = \overline{1 \cdot 1} = 0.$$

Overall, we have $X_1 = 0, X_2 = 1$.

* Consider $A = 0, B = 1$.

$$\rightarrow X_1 = 1, X_2 = 0.$$

* Consider $A = B = 1$.

$$X_1 = \overline{A X_2} = \overline{X_2}, X_2 = \overline{B X_1} = \overline{X_1} \Rightarrow \boxed{X_1 = \overline{X_2}}$$

If $X_1 = 1, X_2 = 0$ previously, the circuit continues to "hold" that state.

NAND latch (RS latch)

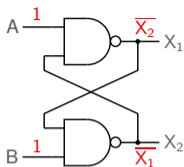

A	B	X ₁	X ₂
1	0	0	1
0	1	1	0
1	1	previous	
0	0		

* A, B: inputs, X₁, X₂: outputs

* Consider A = 1, B = 0.

$$B = 0 \Rightarrow X_2 = 1 \Rightarrow X_1 = \overline{A X_2} = \overline{1 \cdot 1} = 0.$$

Overall, we have X₁ = 0, X₂ = 1.

* Consider A = 0, B = 1.

$$\rightarrow X_1 = 1, X_2 = 0.$$

* Consider A = B = 1.

$$X_1 = \overline{A X_2} = \overline{X_2}, X_2 = \overline{B X_1} = \overline{X_1} \Rightarrow \boxed{X_1 = \overline{X_2}}$$

If X₁ = 1, X₂ = 0 previously, the circuit continues to “hold” that state.

Similarly, if X₁ = 0, X₂ = 1 previously, the circuit continues to “hold” that state.

NAND latch (RS latch)

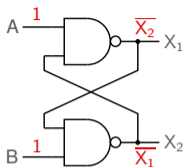

A	B	X ₁	X ₂
1	0	0	1
0	1	1	0
1	1	previous	
0	0		

* A, B : inputs, X_1, X_2 : outputs

* Consider $A = 1, B = 0$.

$$B = 0 \Rightarrow X_2 = 1 \Rightarrow X_1 = \overline{A X_2} = \overline{1 \cdot 1} = 0.$$

Overall, we have $X_1 = 0, X_2 = 1$.

* Consider $A = 0, B = 1$.

$$\rightarrow X_1 = 1, X_2 = 0.$$

* Consider $A = B = 1$.

$$X_1 = \overline{A X_2} = \overline{X_2}, X_2 = \overline{B X_1} = \overline{X_1} \Rightarrow \boxed{X_1 = \overline{X_2}}$$

If $X_1 = 1, X_2 = 0$ previously, the circuit continues to “hold” that state.

Similarly, if $X_1 = 0, X_2 = 1$ previously, the circuit continues to “hold” that state.

The circuit has “latched in” the previous state.

NAND latch (RS latch)

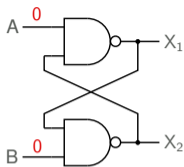

A	B	X ₁	X ₂
1	0	0	1
0	1	1	0
1	1	previous	
0	0		

* A, B : inputs, X_1, X_2 : outputs

* Consider $A = 1, B = 0$.

$$B = 0 \Rightarrow X_2 = 1 \Rightarrow X_1 = \overline{A X_2} = \overline{1 \cdot 1} = 0.$$

Overall, we have $X_1 = 0, X_2 = 1$.

* Consider $A = 0, B = 1$.

$$\rightarrow X_1 = 1, X_2 = 0.$$

* Consider $A = B = 1$.

$$X_1 = \overline{A X_2} = \overline{X_2}, X_2 = \overline{B X_1} = \overline{X_1} \Rightarrow \boxed{X_1 = \overline{X_2}}$$

If $X_1 = 1, X_2 = 0$ previously, the circuit continues to “hold” that state.

Similarly, if $X_1 = 0, X_2 = 1$ previously, the circuit continues to “hold” that state.

The circuit has “latched in” the previous state.

* For $A = B = 0$, X_1 and X_2 are both 1. This combination of A and B is *not* allowed for reasons that will become clear later.

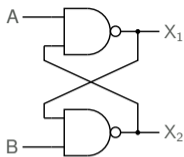

A	B	X ₁	X ₂
1	0	0	1
0	1	1	0
1	1	previous	
0	0	1	1

* A, B: inputs, X₁, X₂: outputs

* Consider A = 1, B = 0.

$$B = 0 \Rightarrow X_2 = 1 \Rightarrow X_1 = \overline{A X_2} = \overline{1 \cdot 1} = 0.$$

Overall, we have X₁ = 0, X₂ = 1.

* Consider A = 0, B = 1.

$$\rightarrow X_1 = 1, X_2 = 0.$$

* Consider A = B = 1.

$$X_1 = \overline{A X_2} = \overline{X_2}, X_2 = \overline{B X_1} = \overline{X_1} \Rightarrow \boxed{X_1 = \overline{X_2}}$$

If X₁ = 1, X₂ = 0 previously, the circuit continues to “hold” that state.

Similarly, if X₁ = 0, X₂ = 1 previously, the circuit continues to “hold” that state.

The circuit has “latched in” the previous state.

* For A = B = 0, X₁ and X₂ are both 1. This combination of A and B is *not* allowed for reasons that will become clear later.

NAND latch (RS latch)

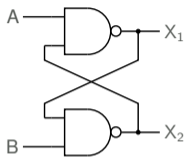

A	B	X ₁	X ₂
1	0	0	1
0	1	1	0
1	1	previous	
0	0	invalid	

NAND latch (RS latch)

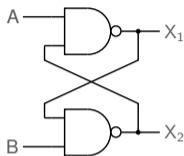

A	B	X_1	X_2
1	0	0	1
0	1	1	0
1	1	previous	previous
0	0	invalid	invalid

* The combination $A=1, B=0$ serves to *reset* X_1 to 0 (*irrespective of the previous state of the latch*).

NAND latch (RS latch)

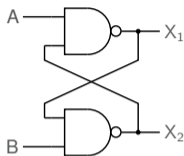

A	B	X_1	X_2
1	0	0	1
0	1	1	0
1	1	previous	
0	0	invalid	

- * The combination $A=1, B=0$ serves to *reset* X_1 to 0 (*irrespective of the previous state of the latch*).
- * The combination $A=0, B=1$ serves to *set* X_1 to 1 (*irrespective of the previous state of the latch*).

NAND latch (RS latch)

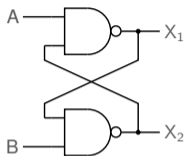

A	B	X_1	X_2
1	0	0	1
0	1	1	0
1	1	previous	
0	0	invalid	

- * The combination $A=1, B=0$ serves to *reset* X_1 to 0 (*irrespective of the previous state of the latch*).
- * The combination $A=0, B=1$ serves to *set* X_1 to 1 (*irrespective of the previous state of the latch*).
- * In other words,
 $A=1, B=0 \rightarrow$ latch gets reset to 0.
 $A=0, B=1 \rightarrow$ latch gets set to 1.

NAND latch (RS latch)

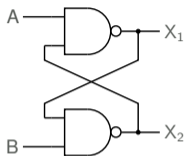

A	B	X_1	X_2
1	0	0	1
0	1	1	0
1	1	previous	
0	0	invalid	

- * The combination $A=1, B=0$ serves to *reset* X_1 to 0 (*irrespective of the previous state of the latch*).
- * The combination $A=0, B=1$ serves to *set* X_1 to 1 (*irrespective of the previous state of the latch*).
- * In other words,
 - $A=1, B=0 \rightarrow$ latch gets reset to 0.
 - $A=0, B=1 \rightarrow$ latch gets set to 1.
- * The A input is therefore called the RESET (R) input, and B is called the SET (S) input of the latch.

NAND latch (RS latch)

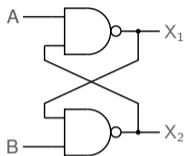

A	B	X_1	X_2
1	0	0	1
0	1	1	0
1	1	previous	
0	0	invalid	

- * The combination $A=1, B=0$ serves to *reset* X_1 to 0 (*irrespective of the previous state of the latch*).
- * The combination $A=0, B=1$ serves to *set* X_1 to 1 (*irrespective of the previous state of the latch*).
- * In other words,
 - $A=1, B=0 \rightarrow$ latch gets reset to 0.
 - $A=0, B=1 \rightarrow$ latch gets set to 1.
- * The A input is therefore called the RESET (R) input, and B is called the SET (S) input of the latch.
- * X_1 is denoted by Q , and X_2 (which is $\overline{X_1}$ in all cases except for $A=B=0$) is denoted by \overline{Q} .

NAND latch (RS latch)

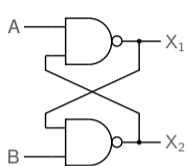

A	B	X_1	X_2
1	0	0	1
0	1	1	0
1	1	previous	
0	0	invalid	

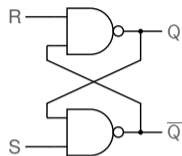

R	S	Q	\bar{Q}
1	0	0	1
0	1	1	0
1	1	previous	
0	0	invalid	

- * The combination $A=1, B=0$ serves to *reset* X_1 to 0 (*irrespective of the previous state of the latch*).
- * The combination $A=0, B=1$ serves to *set* X_1 to 1 (*irrespective of the previous state of the latch*).
- * In other words,
 - $A=1, B=0 \rightarrow$ latch gets reset to 0.
 - $A=0, B=1 \rightarrow$ latch gets set to 1.
- * The A input is therefore called the RESET (R) input, and B is called the SET (S) input of the latch.
- * X_1 is denoted by Q , and X_2 (which is \bar{X}_1 in all cases except for $A=B=0$) is denoted by \bar{Q} .

NAND latch (RS latch)

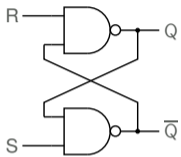

R	S	Q	\bar{Q}
1	0	0	1
0	1	1	0
1	1	previous	
0	0	invalid	

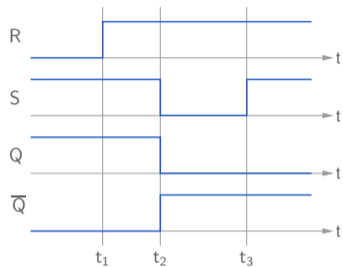

NAND latch (RS latch)

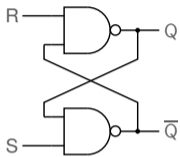

R	S	Q	\bar{Q}
1	0	0	1
0	1	1	0
1	1	previous	
0	0	invalid	

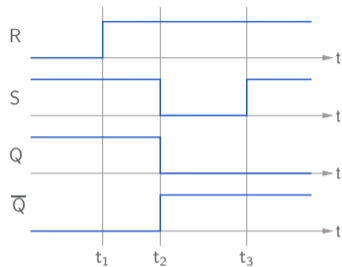

* Up to $t = t_1$, $R=0$, $S=1 \rightarrow Q=1$.

NAND latch (RS latch)

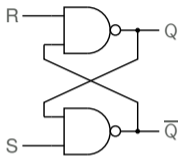

R	S	Q	\bar{Q}
1	0	0	1
0	1	1	0
1	1	previous	
0	0	invalid	

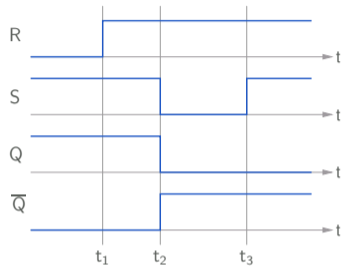

- * Up to $t = t_1$, $R = 0$, $S = 1 \rightarrow Q = 1$.
- * At $t = t_1$, R goes high $\rightarrow R = S = 1$, and the latch holds its previous state \rightarrow no change at the output.

NAND latch (RS latch)

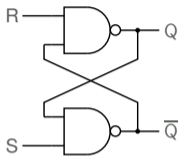

R	S	Q	\bar{Q}
1	0	0	1
0	1	1	0
1	1	previous	
0	0	invalid	

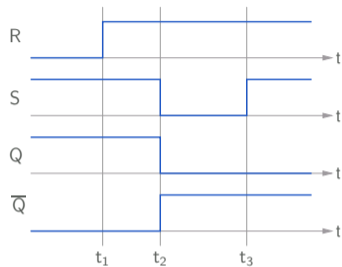

- * Up to $t = t_1$, $R=0$, $S=1 \rightarrow Q=1$.
- * At $t = t_1$, R goes high $\rightarrow R=S=1$, and the latch holds its previous state \rightarrow no change at the output.
- * At $t = t_2$, S goes low $\rightarrow R=1$, $S=0 \rightarrow Q=0$.

NAND latch (RS latch)

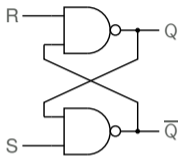

R	S	Q	\bar{Q}
1	0	0	1
0	1	1	0
1	1	previous	
0	0	invalid	

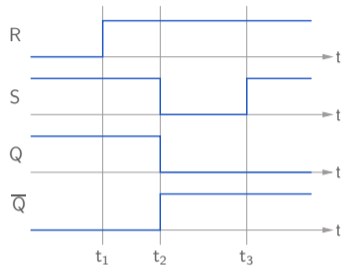

- * Up to $t = t_1$, $R = 0$, $S = 1 \rightarrow Q = 1$.
- * At $t = t_1$, R goes high $\rightarrow R = S = 1$, and the latch holds its previous state \rightarrow no change at the output.
- * At $t = t_2$, S goes low $\rightarrow R = 1$, $S = 0 \rightarrow Q = 0$.
- * At $t = t_3$, S goes high $\rightarrow R = S = 1$, and the latch holds its previous state \rightarrow no change at the output.

NAND latch (RS latch)

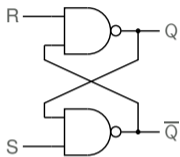

R	S	Q	\bar{Q}
1	0	0	1
0	1	1	0
1	1	previous	
0	0	invalid	

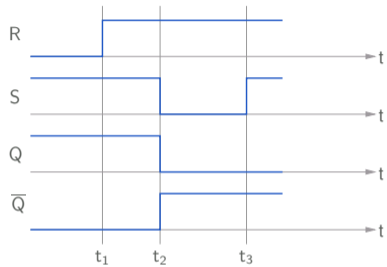

NAND latch (RS latch)

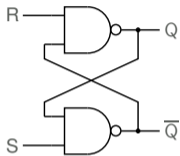

R	S	Q	\bar{Q}
1	0	0	1
0	1	1	0
1	1	previous	
0	0	invalid	

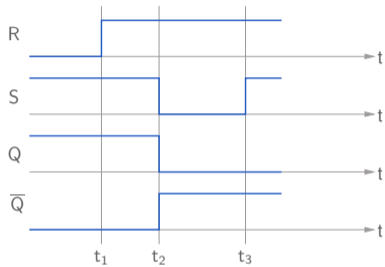

Why not allow $R = S = 0$?

NAND latch (RS latch)

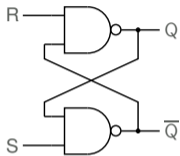

R	S	Q	\bar{Q}
1	0	0	1
0	1	1	0
1	1	previous	
0	0	invalid	

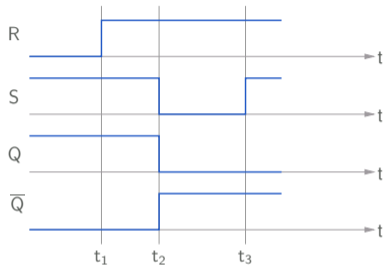

Why not allow $R = S = 0$?

- It makes $Q = \bar{Q} = 1$, i.e., Q and \bar{Q} are not inverse of each other any more.

NAND latch (RS latch)

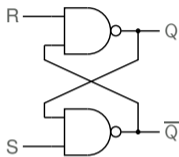

R	S	Q	\bar{Q}
1	0	0	1
0	1	1	0
1	1	previous	
0	0	invalid	

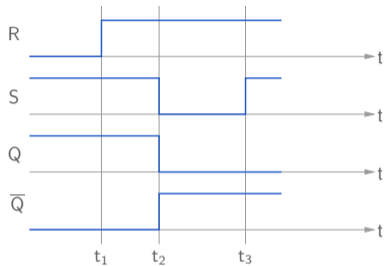

Why not allow $R = S = 0$?

- It makes $Q = \bar{Q} = 1$, i.e., Q and \bar{Q} are not inverse of each other any more.
- More importantly, when R and S both become 1 simultaneously (starting from $R = S = 0$), the final outputs Q and \bar{Q} cannot be uniquely determined. We could have $Q = 0, \bar{Q} = 1$ or $Q = 1, \bar{Q} = 0$, depending on the delays associated with the two NAND gates.

NAND latch (RS latch)

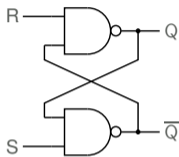

R	S	Q	\bar{Q}
1	0	0	1
0	1	1	0
1	1	previous	
0	0	invalid	

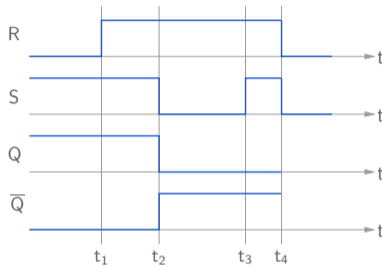

Why not allow $R = S = 0$?

- It makes $Q = \bar{Q} = 1$, i.e., Q and \bar{Q} are not inverse of each other any more.
- More importantly, when R and S both become 1 simultaneously (starting from $R = S = 0$), the final outputs Q and \bar{Q} cannot be uniquely determined. We could have $Q = 0, \bar{Q} = 1$ or $Q = 1, \bar{Q} = 0$, depending on the delays associated with the two NAND gates.

NAND latch (RS latch)

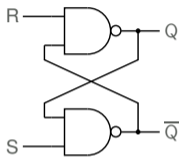

R	S	Q	\bar{Q}
1	0	0	1
0	1	1	0
1	1	previous	
0	0	invalid	

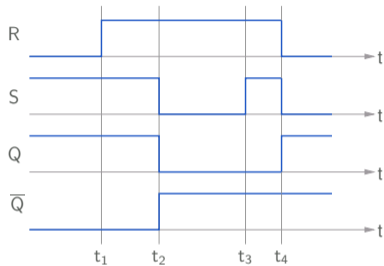

Why not allow $R = S = 0$?

- It makes $Q = \bar{Q} = 1$, i.e., Q and \bar{Q} are not inverse of each other any more.
- More importantly, when R and S both become 1 simultaneously (starting from $R = S = 0$), the final outputs Q and \bar{Q} cannot be uniquely determined. We could have $Q = 0, \bar{Q} = 1$ or $Q = 1, \bar{Q} = 0$, depending on the delays associated with the two NAND gates.

NAND latch (RS latch)

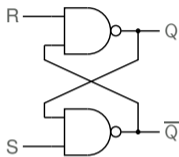

R	S	Q	\bar{Q}
1	0	0	1
0	1	1	0
1	1	previous	
0	0	invalid	

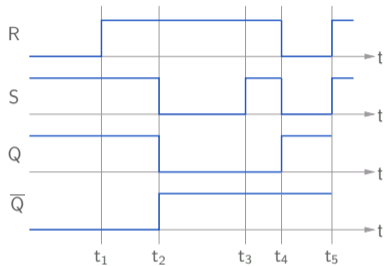

Why not allow $R = S = 0$?

- It makes $Q = \bar{Q} = 1$, i.e., Q and \bar{Q} are not inverse of each other any more.
- More importantly, when R and S both become 1 simultaneously (starting from $R = S = 0$), the final outputs Q and \bar{Q} cannot be uniquely determined. We could have $Q = 0, \bar{Q} = 1$ or $Q = 1, \bar{Q} = 0$, depending on the delays associated with the two NAND gates.

NAND latch (RS latch)

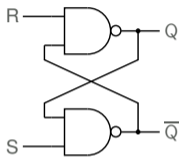

R	S	Q	\bar{Q}
1	0	0	1
0	1	1	0
1	1	previous	
0	0	invalid	

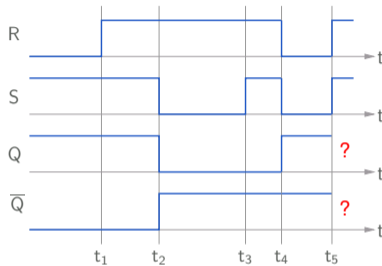

Why not allow $R = S = 0$?

- It makes $Q = \bar{Q} = 1$, i.e., Q and \bar{Q} are not inverse of each other any more.
- More importantly, when R and S both become 1 simultaneously (starting from $R = S = 0$), the final outputs Q and \bar{Q} cannot be uniquely determined. We could have $Q = 0, \bar{Q} = 1$ or $Q = 1, \bar{Q} = 0$, depending on the delays associated with the two NAND gates.

NAND latch (RS latch)

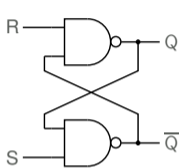

R	S	Q	\bar{Q}
1	0	0	1
0	1	1	0
1	1	previous	
0	0	invalid	

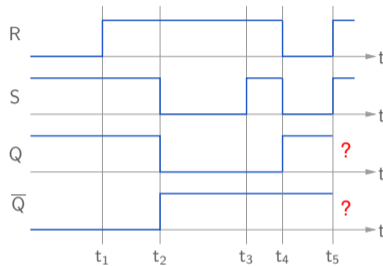

Why not allow $R = S = 0$?

- It makes $Q = \bar{Q} = 1$, i.e., Q and \bar{Q} are not inverse of each other any more.
- More importantly, when R and S both become 1 simultaneously (starting from $R = S = 0$), the final outputs Q and \bar{Q} cannot be uniquely determined. We could have $Q = 0, \bar{Q} = 1$ or $Q = 1, \bar{Q} = 0$, depending on the delays associated with the two NAND gates.

NOR latch (RS latch)

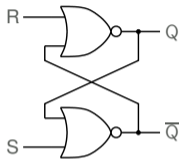

R	S	Q	\bar{Q}
1	0	0	1
0	1	1	0
0	0	previous	
1	1	invalid	

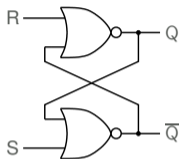

R	S	Q	\bar{Q}
1	0	0	1
0	1	1	0
0	0	previous	
1	1	invalid	

- * The NOR latch is similar to the NAND latch:
 When $R=1, S=0$, the latch gets *reset* to $Q=0$.
 When $R=0, S=1$, the latch gets *set* to $Q=1$.

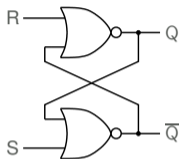

R	S	Q	\bar{Q}
1	0	0	1
0	1	1	0
0	0	previous	
1	1	invalid	

- * The NOR latch is similar to the NAND latch:
 When $R=1, S=0$, the latch gets *reset* to $Q=0$.
 When $R=0, S=1$, the latch gets *set* to $Q=1$.
- * For $R=S=0$, the latch retains its previous state (i.e., the previous values of Q and \bar{Q}).

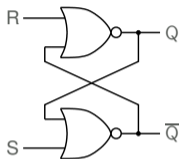

R	S	Q	\bar{Q}
1	0	0	1
0	1	1	0
0	0	previous	
1	1	invalid	

- * The NOR latch is similar to the NAND latch:
When $R=1, S=0$, the latch gets *reset* to $Q=0$.
When $R=0, S=1$, the latch gets *set* to $Q=1$.
- * For $R=S=0$, the latch retains its previous state (i.e., the previous values of Q and \bar{Q}).
- * $R=S=1$ is not allowed for reasons similar to those discussed in the context of the NAND latch.

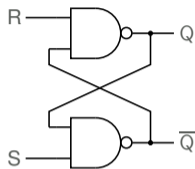

R	S	Q	\bar{Q}
1	0	0	1
0	1	1	0
1	1	previous	
0	0	invalid	

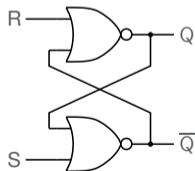

R	S	Q	\bar{Q}
1	0	0	1
0	1	1	0
0	0	previous	
1	1	invalid	

NAND latch: alternative node names

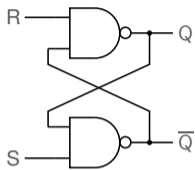

R	S	Q	\bar{Q}
1	0	0	1
0	1	1	0
1	1	previous	
0	0	invalid	

NAND latch: alternative node names

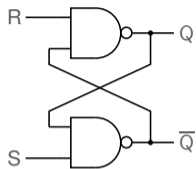

R	S	Q	\bar{Q}
1	0	0	1
0	1	1	0
1	1	previous	
0	0	invalid	

Active low input nodes:

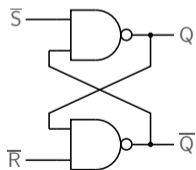

\bar{S}	\bar{R}	Q	\bar{Q}
1	0	0	1
0	1	1	0
1	1	previous	
0	0	invalid	

Chatter (bouncing) due to a mechanical switch

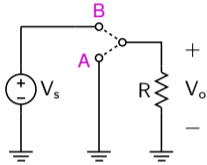

Chatter (bouncing) due to a mechanical switch

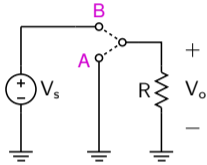

- * When the switch is thrown from A to B, V_o is expected to go from 0 V to V_s (say, 5 V).

Chatter (bouncing) due to a mechanical switch

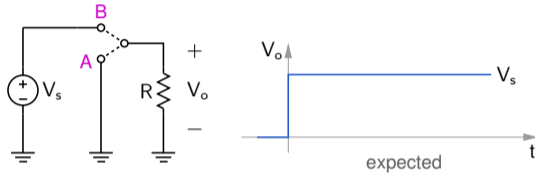

* When the switch is thrown from A to B, V_o is expected to go from 0 V to V_s (say, 5 V).

Chatter (bouncing) due to a mechanical switch

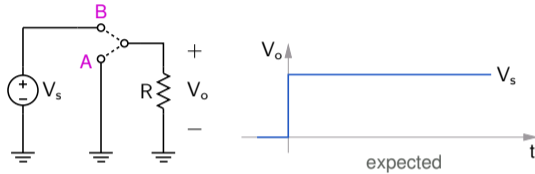

- * When the switch is thrown from A to B, V_o is expected to go from 0 V to V_s (say, 5 V).
- * However, mechanical switches suffer from “chatter” or “bouncing,” i.e., the transition from A to B is not a single, clean one. As a result, V_o oscillates between 0 V and 5 V before settling to its final value (5 V).

Chatter (bouncing) due to a mechanical switch

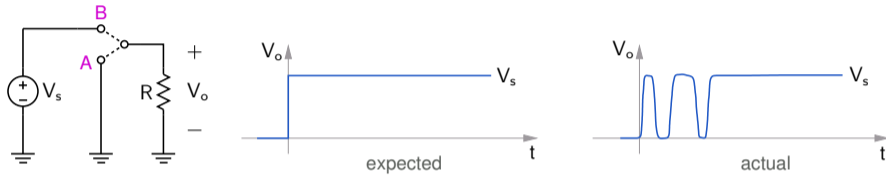

- * When the switch is thrown from A to B, V_o is expected to go from 0 V to V_s (say, 5 V).
- * However, mechanical switches suffer from “chatter” or “bouncing,” i.e., the transition from A to B is not a single, clean one. As a result, V_o oscillates between 0 V and 5 V before settling to its final value (5 V).

Chatter (bouncing) due to a mechanical switch

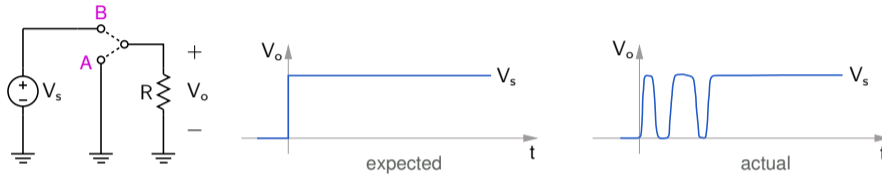

- * When the switch is thrown from A to B, V_o is expected to go from 0 V to V_s (say, 5 V).
- * However, mechanical switches suffer from “chatter” or “bouncing,” i.e., the transition from A to B is not a single, clean one. As a result, V_o oscillates between 0 V and 5 V before settling to its final value (5 V).
- * In some applications, this chatter can cause malfunction → need a way to remove the chatter.

Chatter (bouncing) due to a mechanical switch

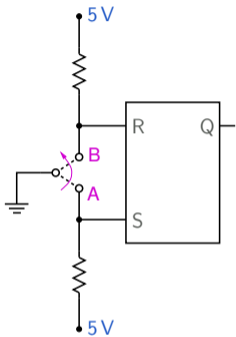

R	S	Q	\bar{Q}
1	0	0	1
0	1	1	0
1	1	previous	
0	0	invalid	

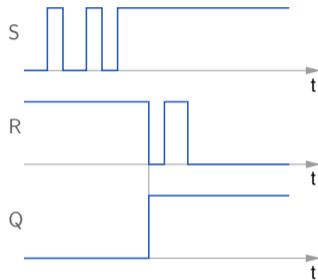

Chatter (bouncing) due to a mechanical switch

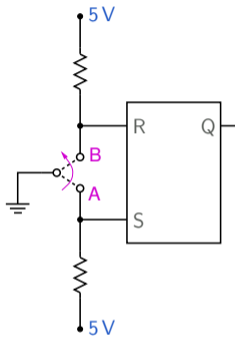

R	S	Q	\bar{Q}
1	0	0	1
0	1	1	0
1	1	previous	
0	0	invalid	

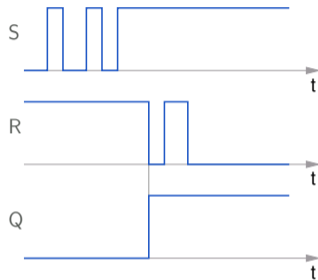

- * Because of the chatter, the S and R inputs may have multiple transitions when the switch is thrown from A to B.

Chatter (bouncing) due to a mechanical switch

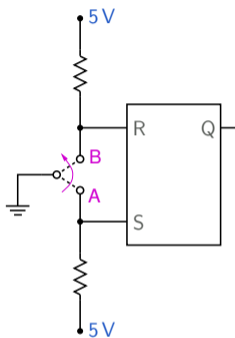

R	S	Q	\bar{Q}
1	0	0	1
0	1	1	0
1	1	previous	
0	0	invalid	

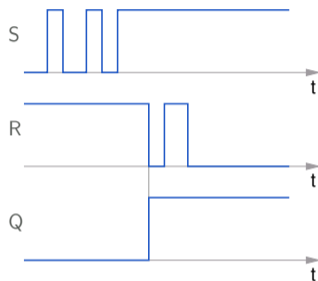

- * Because of the chatter, the S and R inputs may have multiple transitions when the switch is thrown from A to B .
- * However, for $S = R = 1$, the previous value of Q is retained, causing a *single* transition in Q , as desired.

The “clock”

- * Complex digital circuits are generally designed for *synchronous* operation, i.e., transitions in the various signals are synchronised with the *clock*.

The “clock”

- * Complex digital circuits are generally designed for *synchronous* operation, i.e., transitions in the various signals are synchronised with the *clock*.
- * Synchronous circuits are easier to design and troubleshoot because the voltages at the nodes (both output nodes and internal nodes) can change only at specific times.

The “clock”

- * Complex digital circuits are generally designed for *synchronous* operation, i.e., transitions in the various signals are synchronised with the *clock*.
- * Synchronous circuits are easier to design and troubleshoot because the voltages at the nodes (both output nodes and internal nodes) can change only at specific times.
- * A clock is a periodic signal, with a positive-going transition and a negative-going transition.

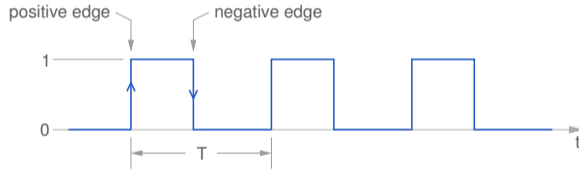

The “clock”

- * Complex digital circuits are generally designed for *synchronous* operation, i.e., transitions in the various signals are synchronised with the *clock*.
- * Synchronous circuits are easier to design and troubleshoot because the voltages at the nodes (both output nodes and internal nodes) can change only at specific times.
- * A clock is a periodic signal, with a positive-going transition and a negative-going transition.

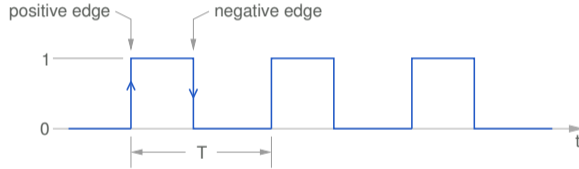

- * The clock frequency determines the overall speed of the circuit. For example, a processor that operates with a 1 GHz clock is 10 times faster than one that operates with a 100 MHz clock.

The “clock”

- * Complex digital circuits are generally designed for *synchronous* operation, i.e., transitions in the various signals are synchronised with the *clock*.
- * Synchronous circuits are easier to design and troubleshoot because the voltages at the nodes (both output nodes and internal nodes) can change only at specific times.
- * A clock is a periodic signal, with a positive-going transition and a negative-going transition.

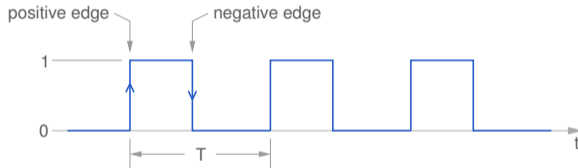

- * The clock frequency determines the overall speed of the circuit. For example, a processor that operates with a 1 GHz clock is 10 times faster than one that operates with a 100 MHz clock.

Intel 80286 (IBM PC-AT): 6 MHz

Modern CPU chips: 2 to 3 GHz.

Clocked RS latch

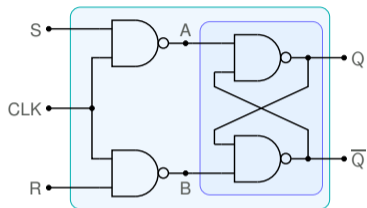

Clocked RS latch

CLK	R	S	Q	\bar{Q}
0	X	X	previous	
1	1	0	0	1
1	0	1	1	0
1	0	0	previous	
1	1	1	invalid	

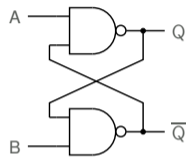

NAND RS latch

A	B	Q	\bar{Q}
1	0	0	1
0	1	1	0
1	1	previous	
0	0	invalid	

Clocked RS latch

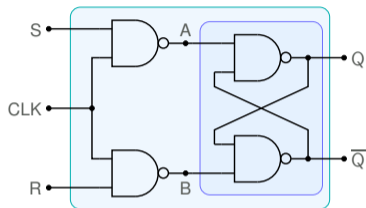

Clocked RS latch

CLK	R	S	Q	\bar{Q}
0	X	X	previous	
1	1	0	0	1
1	0	1	1	0
1	0	0	previous	
1	1	1	invalid	

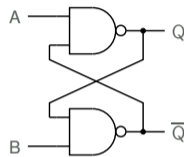

NAND RS latch

A	B	Q	\bar{Q}
1	0	0	1
0	1	1	0
1	1	previous	
0	0	invalid	

* When clock is inactive (0), $A = B = 1$, and the latch holds the previous state.

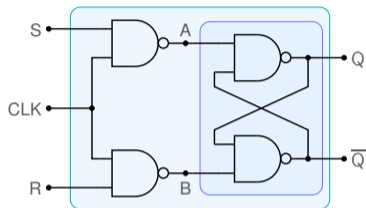

Clocked RS latch

CLK	R	S	Q	\bar{Q}
0	X	X	previous	
1	1	0	0	1
1	0	1	1	0
1	0	0	previous	
1	1	1	invalid	

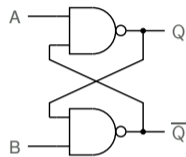

NAND RS latch

A	B	Q	\bar{Q}
1	0	0	1
0	1	1	0
1	1	previous	
0	0	invalid	

- * When clock is inactive (0), $A = B = 1$, and the latch holds the previous state.
- * When clock is active (1), $A = \bar{S}$, $B = \bar{R}$. Using the truth table for the NAND RS latch (right), we can construct the truth table for the clocked RS latch.

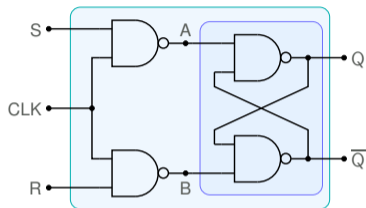

Clocked RS latch

CLK	R	S	Q	\bar{Q}
0	X	X	previous	
1	1	0	0	1
1	0	1	1	0
1	0	0	previous	
1	1	1	invalid	

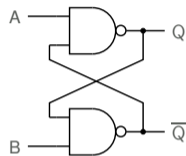

NAND RS latch

A	B	Q	\bar{Q}
1	0	0	1
0	1	1	0
1	1	previous	
0	0	invalid	

- * When clock is inactive (0), $A = B = 1$, and the latch holds the previous state.
- * When clock is active (1), $A = \bar{S}$, $B = \bar{R}$. Using the truth table for the NAND RS latch (right), we can construct the truth table for the clocked RS latch.
- * Note that the above table is sensitive to the *level* of the clock (i.e., whether CLK is 0 or 1).

Clocked RS latch

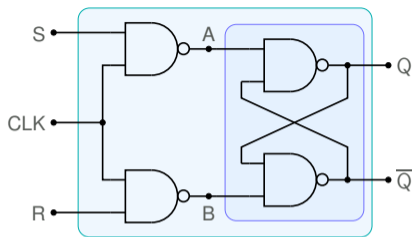

CLK	R	S	Q	\bar{Q}
0	X	X	previous	
1	1	0	0	1
1	0	1	1	0
1	0	0	previous	
1	1	1	invalid	

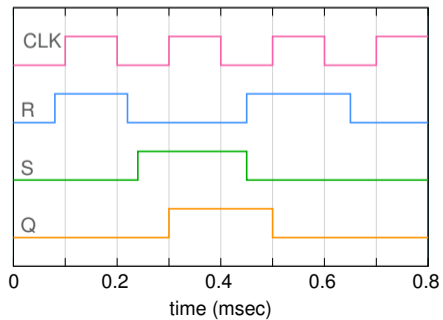

- * The clocked RS latch seen previously is *level-sensitive*, i.e., if the clock is active ($CLK = 1$), the flip-flop output is allowed to change, depending on the R and S inputs.

- * The clocked RS latch seen previously is *level-sensitive*, i.e., if the clock is active ($CLK = 1$), the flip-flop output is allowed to change, depending on the R and S inputs.
- * In an *edge-sensitive* flip-flop, the output can change only at the active clock *edge* (i.e., CLK transition from 0 to 1 or from 1 to 0).

Edge-triggered flip-flops

- * The clocked RS latch seen previously is *level-sensitive*, i.e., if the clock is active ($CLK = 1$), the flip-flop output is allowed to change, depending on the R and S inputs.
- * In an *edge-sensitive* flip-flop, the output can change only at the active clock *edge* (i.e., CLK transition from 0 to 1 or from 1 to 0).
- * Edge-sensitive flip-flops are denoted by the following symbols:

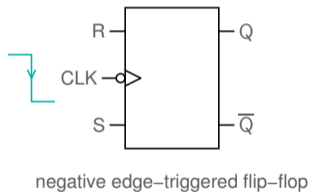
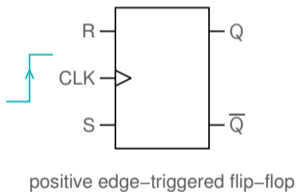

R	S	Q	\bar{Q}
1	0	0	1
0	1	1	0
1	1	previous	
0	0	invalid	

Truth table for RS latch

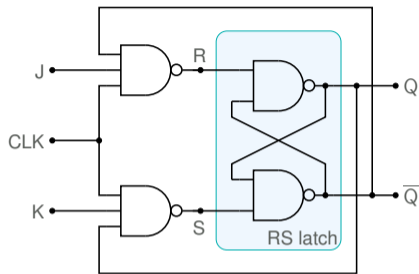

R	S	Q	\bar{Q}
1	0	0	1
0	1	1	0
1	1	previous	
0	0	invalid	

Truth table for RS latch

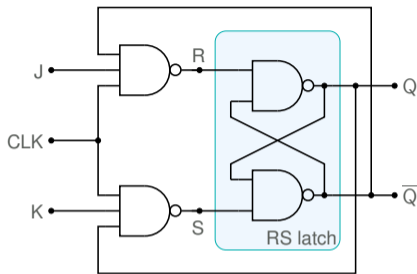

- * When $CLK = 0$, we have $R = S = 1$, and the RS latch holds the previous Q . In other words, nothing happens as long as $CLK = 0$.

R	S	Q	\bar{Q}
1	0	0	1
0	1	1	0
1	1	previous	
0	0	invalid	

Truth table for RS latch

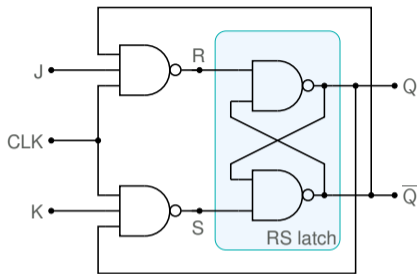

CLK	J	K	Q (Q_{n+1})
0	X	X	previous (Q_n)

Truth table for JK flip-flop

- * When $CLK = 0$, we have $R = S = 1$, and the RS latch holds the previous Q . In other words, nothing happens as long as $CLK = 0$.

R	S	Q	\bar{Q}
1	0	0	1
0	1	1	0
1	1	previous	
0	0	invalid	

Truth table for RS latch

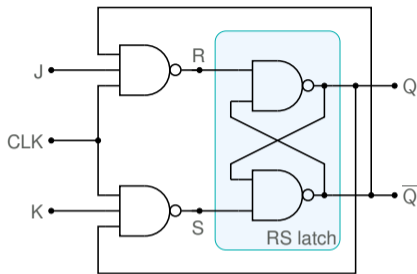

CLK	J	K	Q (Q_{n+1})
0	X	X	previous (Q_n)

Truth table for JK flip-flop

- * When $CLK = 0$, we have $R = S = 1$, and the RS latch holds the previous Q . In other words, nothing happens as long as $CLK = 0$.
- * When $CLK = 1$:

R	S	Q	\bar{Q}
1	0	0	1
0	1	1	0
1	1	previous	
0	0	invalid	

Truth table for RS latch

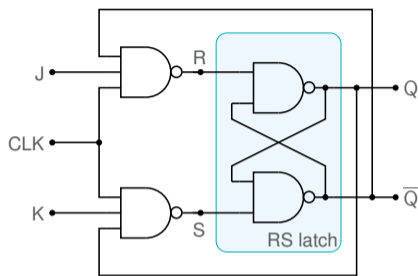

CLK	J	K	Q (Q_{n+1})
0	X	X	previous (Q_n)

Truth table for JK flip-flop

- * When $CLK = 0$, we have $R = S = 1$, and the RS latch holds the previous Q . In other words, nothing happens as long as $CLK = 0$.
- * When $CLK = 1$:
 - $J = K = 0 \rightarrow R = S = 1$, RS latch holds previous Q , i.e., $Q_{n+1} = Q_n$, where n denotes the n^{th} clock pulse (This notation will become clear shortly).

R	S	Q	\bar{Q}
1	0	0	1
0	1	1	0
1	1	previous	
0	0	invalid	

Truth table for RS latch

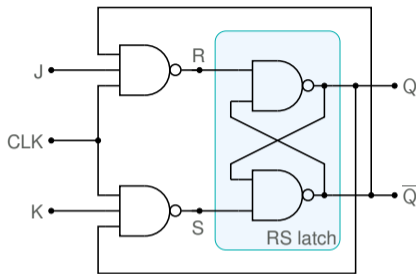

CLK	J	K	Q (Q_{n+1})
0	X	X	previous (Q_n)
1	0	0	previous (Q_n)

Truth table for JK flip-flop

- * When $CLK = 0$, we have $R = S = 1$, and the RS latch holds the previous Q . In other words, nothing happens as long as $CLK = 0$.
- * When $CLK = 1$:
 - $J = K = 0 \rightarrow R = S = 1$, RS latch holds previous Q , i.e., $Q_{n+1} = Q_n$, where n denotes the n^{th} clock pulse (This notation will become clear shortly).

R	S	Q	\bar{Q}
1	0	0	1
0	1	1	0
1	1	previous	
0	0	invalid	

Truth table for RS latch

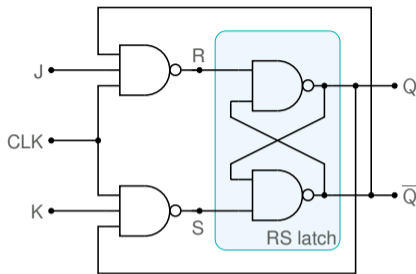

CLK	J	K	Q (Q_{n+1})
0	X	X	previous (Q_n)
1	0	0	previous (Q_n)

Truth table for JK flip-flop

- * When $CLK = 0$, we have $R = S = 1$, and the RS latch holds the previous Q . In other words, nothing happens as long as $CLK = 0$.
- * When $CLK = 1$:
 - $J = K = 0 \rightarrow R = S = 1$, RS latch holds previous Q , i.e., $Q_{n+1} = Q_n$, where n denotes the n^{th} clock pulse (This notation will become clear shortly).
 - $J = 0, K = 1 \rightarrow R = 1, S = \overline{Q_n}$.

R	S	Q	\bar{Q}
1	0	0	1
0	1	1	0
1	1	previous	
0	0	invalid	

Truth table for RS latch

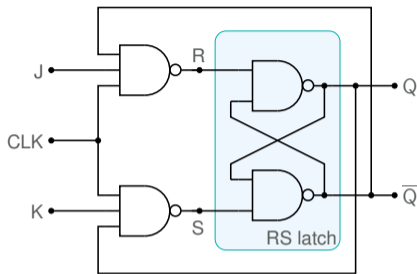

CLK	J	K	Q (Q_{n+1})
0	X	X	previous (Q_n)
1	0	0	previous (Q_n)

Truth table for JK flip-flop

- * When $CLK = 0$, we have $R = S = 1$, and the RS latch holds the previous Q . In other words, nothing happens as long as $CLK = 0$.
- * When $CLK = 1$:
 - $J = K = 0 \rightarrow R = S = 1$, RS latch holds previous Q , i.e., $Q_{n+1} = Q_n$, where n denotes the n^{th} clock pulse (This notation will become clear shortly).
 - $J = 0, K = 1 \rightarrow R = 1, S = \bar{Q}_n$.
Case (i): $Q_n = 0 \rightarrow S = 1$ (i.e., $R = S = 1$) $\rightarrow Q_{n+1} = Q_n = 0$.

R	S	Q	\bar{Q}
1	0	0	1
0	1	1	0
1	1	previous	
0	0	invalid	

Truth table for RS latch

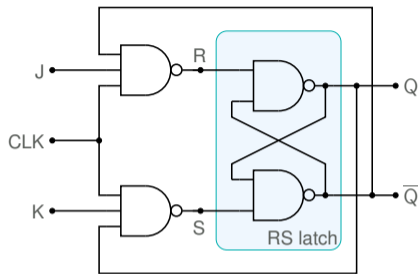

CLK	J	K	Q (Q_{n+1})
0	X	X	previous (Q_n)
1	0	0	previous (Q_n)

Truth table for JK flip-flop

- * When $CLK = 0$, we have $R = S = 1$, and the RS latch holds the previous Q . In other words, nothing happens as long as $CLK = 0$.
- * When $CLK = 1$:
 - $J = K = 0 \rightarrow R = S = 1$, RS latch holds previous Q , i.e., $Q_{n+1} = Q_n$, where n denotes the n^{th} clock pulse (This notation will become clear shortly).
 - $J = 0, K = 1 \rightarrow R = 1, S = \bar{Q}_n$.
 - Case (i): $Q_n = 0 \rightarrow S = 1$ (i.e., $R = S = 1$) $\rightarrow Q_{n+1} = Q_n = 0$.
 - Case (ii): $Q_n = 1 \rightarrow S = 0$ (i.e., $R = 1, S = 0$) $\rightarrow Q_{n+1} = 0$.

R	S	Q	\bar{Q}
1	0	0	1
0	1	1	0
1	1	previous	
0	0	invalid	

Truth table for RS latch

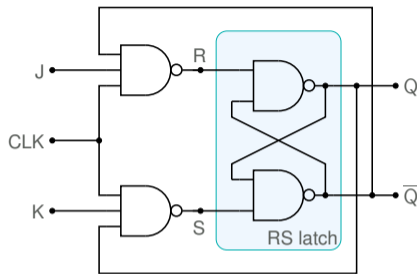

CLK	J	K	Q (Q_{n+1})
0	X	X	previous (Q_n)
1	0	0	previous (Q_n)

Truth table for JK flip-flop

- * When $CLK = 0$, we have $R = S = 1$, and the RS latch holds the previous Q . In other words, nothing happens as long as $CLK = 0$.
- * When $CLK = 1$:
 - $J = K = 0 \rightarrow R = S = 1$, RS latch holds previous Q , i.e., $Q_{n+1} = Q_n$, where n denotes the n^{th} clock pulse (This notation will become clear shortly).
 - $J = 0, K = 1 \rightarrow R = 1, S = \bar{Q}_n$.
 - Case (i): $Q_n = 0 \rightarrow S = 1$ (i.e., $R = S = 1$) $\rightarrow Q_{n+1} = Q_n = 0$.
 - Case (ii): $Q_n = 1 \rightarrow S = 0$ (i.e., $R = 1, S = 0$) $\rightarrow Q_{n+1} = 0$.
 In either case, $Q_{n+1} = 0 \rightarrow$ For $J = 0, K = 1, Q_{n+1} = 0$.

R	S	Q	\bar{Q}
1	0	0	1
0	1	1	0
1	1	previous	
0	0	invalid	

Truth table for RS latch

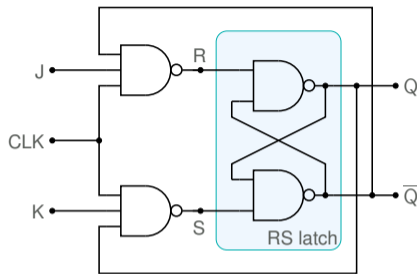

CLK	J	K	Q (Q_{n+1})
0	X	X	previous (Q_n)
1	0	0	previous (Q_n)
1	0	1	0

Truth table for JK flip-flop

- * When $CLK = 0$, we have $R = S = 1$, and the RS latch holds the previous Q . In other words, nothing happens as long as $CLK = 0$.
- * When $CLK = 1$:
 - $J = K = 0 \rightarrow R = S = 1$, RS latch holds previous Q , i.e., $Q_{n+1} = Q_n$, where n denotes the n^{th} clock pulse (This notation will become clear shortly).
 - $J = 0, K = 1 \rightarrow R = 1, S = \bar{Q}_n$.
 - Case (i): $Q_n = 0 \rightarrow S = 1$ (i.e., $R = S = 1$) $\rightarrow Q_{n+1} = Q_n = 0$.
 - Case (ii): $Q_n = 1 \rightarrow S = 0$ (i.e., $R = 1, S = 0$) $\rightarrow Q_{n+1} = 0$.
 In either case, $Q_{n+1} = 0 \rightarrow$ For $J = 0, K = 1, Q_{n+1} = 0$.

R	S	Q	\bar{Q}
1	0	0	1
0	1	1	0
1	1	previous	
0	0	invalid	

Truth table for RS latch

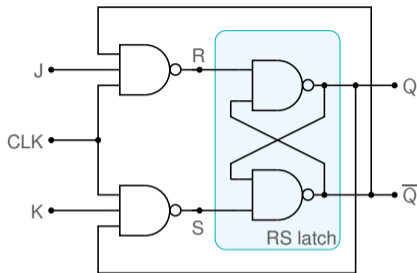

CLK	J	K	Q (Q_{n+1})
0	X	X	previous (Q_n)
1	0	0	previous (Q_n)
1	0	1	0

Truth table for JK flip-flop

R	S	Q	\bar{Q}
1	0	0	1
0	1	1	0
1	1	previous	
0	0	invalid	

Truth table for RS latch

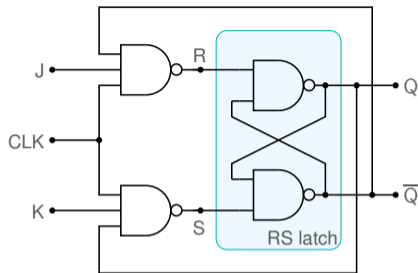

CLK	J	K	Q (Q_{n+1})
0	X	X	previous (Q_n)
1	0	0	previous (Q_n)
1	0	1	0

Truth table for JK flip-flop

* When CLK = 1:

- Consider $J = 1, K = 0 \rightarrow S = 1, R = \overline{\overline{Q_n}} = Q_n$.

R	S	Q	\bar{Q}
1	0	0	1
0	1	1	0
1	1	previous	
0	0	invalid	

Truth table for RS latch

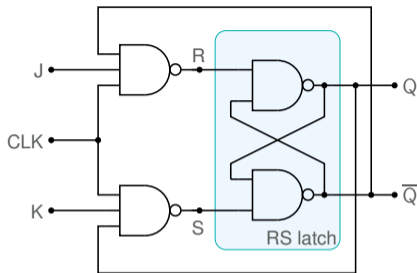

CLK	J	K	Q (Q_{n+1})
0	X	X	previous (Q_n)
1	0	0	previous (Q_n)
1	0	1	0

Truth table for JK flip-flop

* When CLK = 1:

- Consider $J = 1, K = 0 \rightarrow S = 1, R = \overline{\overline{Q_n}} = Q_n$.

Case (i): $Q_n = 0 \rightarrow R = 0$ (i.e., $R = 0, S = 1$) $\rightarrow Q_{n+1} = 1$.

R	S	Q	\bar{Q}
1	0	0	1
0	1	1	0
1	1	previous	
0	0	invalid	

Truth table for RS latch

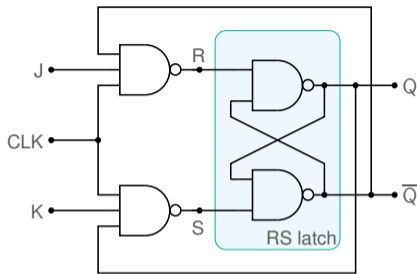

CLK	J	K	Q (Q_{n+1})
0	X	X	previous (Q_n)
1	0	0	previous (Q_n)
1	0	1	0

Truth table for JK flip-flop

* When CLK = 1:

- Consider $J = 1, K = 0 \rightarrow S = 1, R = \overline{\overline{Q_n}} = Q_n$.

Case (i): $Q_n = 0 \rightarrow R = 0$ (i.e., $R = 0, S = 1$) $\rightarrow Q_{n+1} = 1$.

Case (ii): $Q_n = 1 \rightarrow R = 1$ (i.e., $R = 1, S = 1$) $\rightarrow Q_{n+1} = Q_n = 1$.

R	S	Q	\bar{Q}
1	0	0	1
0	1	1	0
1	1	previous	
0	0	invalid	

Truth table for RS latch

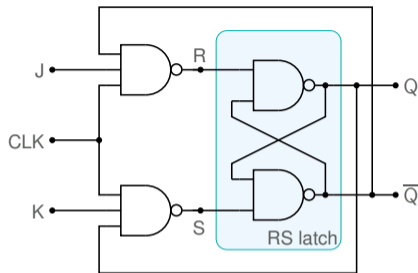

CLK	J	K	Q (Q_{n+1})
0	X	X	previous (Q_n)
1	0	0	previous (Q_n)
1	0	1	0

Truth table for JK flip-flop

* When CLK = 1:

- Consider $J = 1, K = 0 \rightarrow S = 1, R = \overline{\overline{Q_n}} = Q_n$.
 Case (i): $Q_n = 0 \rightarrow R = 0$ (i.e., $R = 0, S = 1$) $\rightarrow Q_{n+1} = 1$.
 Case (ii): $Q_n = 1 \rightarrow R = 1$ (i.e., $R = 1, S = 1$) $\rightarrow Q_{n+1} = Q_n = 1$.
 \rightarrow For $J = 1, K = 0, Q_{n+1} = 1$.

R	S	Q	\bar{Q}
1	0	0	1
0	1	1	0
1	1	previous	
0	0	invalid	

Truth table for RS latch

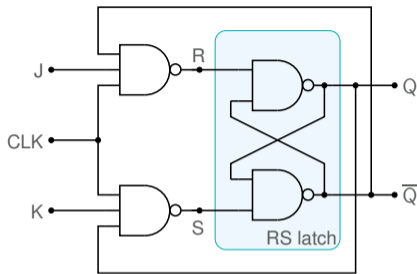

CLK	J	K	Q (Q_{n+1})
0	X	X	previous (Q_n)
1	0	0	previous (Q_n)
1	0	1	0
1	1	0	1

Truth table for JK flip-flop

* When CLK = 1:

- Consider $J = 1, K = 0 \rightarrow S = 1, R = \overline{\overline{Q_n}} = Q_n$.
- Case (i): $Q_n = 0 \rightarrow R = 0$ (i.e., $R = 0, S = 1$) $\rightarrow Q_{n+1} = 1$.
- Case (ii): $Q_n = 1 \rightarrow R = 1$ (i.e., $R = 1, S = 1$) $\rightarrow Q_{n+1} = Q_n = 1$.
- \rightarrow For $J = 1, K = 0, Q_{n+1} = 1$.

R	S	Q	\bar{Q}
1	0	0	1
0	1	1	0
1	1	previous	
0	0	invalid	

Truth table for RS latch

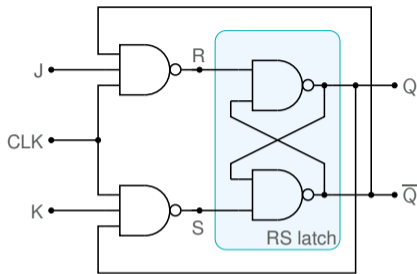

CLK	J	K	Q (Q_{n+1})
0	X	X	previous (Q_n)
1	0	0	previous (Q_n)
1	0	1	0
1	1	0	1

Truth table for JK flip-flop

* When CLK = 1:

- Consider $J = 1, K = 0 \rightarrow S = 1, R = \overline{\overline{Q_n}} = Q_n$.
 - Case (i): $Q_n = 0 \rightarrow R = 0$ (i.e., $R = 0, S = 1$) $\rightarrow Q_{n+1} = 1$.
 - Case (ii): $Q_n = 1 \rightarrow R = 1$ (i.e., $R = 1, S = 1$) $\rightarrow Q_{n+1} = Q_n = 1$.
 - \rightarrow For $J = 1, K = 0, Q_{n+1} = 1$.
- Consider $J = 1, K = 1 \rightarrow R = Q_n, S = \overline{Q_n}$.

R	S	Q	\bar{Q}
1	0	0	1
0	1	1	0
1	1	previous	
0	0	invalid	

Truth table for RS latch

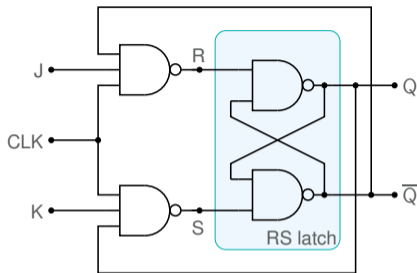

CLK	J	K	Q (Q_{n+1})
0	X	X	previous (Q_n)
1	0	0	previous (Q_n)
1	0	1	0
1	1	0	1

Truth table for JK flip-flop

* When CLK = 1:

- Consider $J = 1, K = 0 \rightarrow S = 1, R = \overline{\overline{Q_n}} = Q_n$.
 - Case (i): $Q_n = 0 \rightarrow R = 0$ (i.e., $R = 0, S = 1$) $\rightarrow Q_{n+1} = 1$.
 - Case (ii): $Q_n = 1 \rightarrow R = 1$ (i.e., $R = 1, S = 1$) $\rightarrow Q_{n+1} = Q_n = 1$.
 - \rightarrow For $J = 1, K = 0, Q_{n+1} = 1$.
- Consider $J = 1, K = 1 \rightarrow R = Q_n, S = \overline{Q_n}$.
 - Case (i): $Q_n = 0 \rightarrow R = 0, S = 1 \rightarrow Q_{n+1} = 1$.

R	S	Q	\bar{Q}
1	0	0	1
0	1	1	0
1	1	previous	
0	0	invalid	

Truth table for RS latch

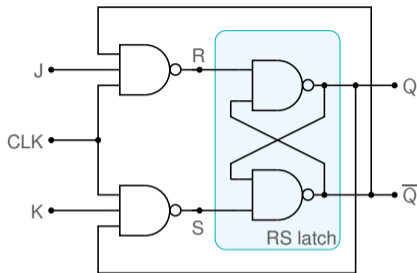

CLK	J	K	Q (Q_{n+1})
0	X	X	previous (Q_n)
1	0	0	previous (Q_n)
1	0	1	0
1	1	0	1

Truth table for JK flip-flop

* When CLK = 1:

- Consider $J = 1, K = 0 \rightarrow S = 1, R = \overline{\overline{Q_n}} = Q_n$.
 - Case (i): $Q_n = 0 \rightarrow R = 0$ (i.e., $R = 0, S = 1$) $\rightarrow Q_{n+1} = 1$.
 - Case (ii): $Q_n = 1 \rightarrow R = 1$ (i.e., $R = 1, S = 1$) $\rightarrow Q_{n+1} = Q_n = 1$.
 - \rightarrow For $J = 1, K = 0, Q_{n+1} = 1$.
- Consider $J = 1, K = 1 \rightarrow R = Q_n, S = \overline{Q_n}$.
 - Case (i): $Q_n = 0 \rightarrow R = 0, S = 1 \rightarrow Q_{n+1} = 1$.
 - Case (ii): $Q_n = 1 \rightarrow R = 1, S = 0 \rightarrow Q_{n+1} = 0$.

R	S	Q	\bar{Q}
1	0	0	1
0	1	1	0
1	1	previous	
0	0	invalid	

Truth table for RS latch

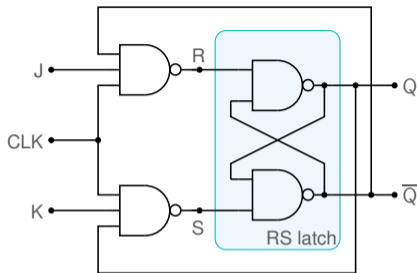

CLK	J	K	Q (Q_{n+1})
0	X	X	previous (Q_n)
1	0	0	previous (Q_n)
1	0	1	0
1	1	0	1

Truth table for JK flip-flop

* When CLK = 1:

- Consider $J = 1, K = 0 \rightarrow S = 1, R = \overline{\overline{Q_n}} = Q_n$.
 - Case (i): $Q_n = 0 \rightarrow R = 0$ (i.e., $R = 0, S = 1$) $\rightarrow Q_{n+1} = 1$.
 - Case (ii): $Q_n = 1 \rightarrow R = 1$ (i.e., $R = 1, S = 1$) $\rightarrow Q_{n+1} = Q_n = 1$.
 - \rightarrow For $J = 1, K = 0, Q_{n+1} = 1$.
- Consider $J = 1, K = 1 \rightarrow R = Q_n, S = \overline{Q_n}$.
 - Case (i): $Q_n = 0 \rightarrow R = 0, S = 1 \rightarrow Q_{n+1} = 1$.
 - Case (ii): $Q_n = 1 \rightarrow R = 1, S = 0 \rightarrow Q_{n+1} = 0$.
 - \rightarrow For $J = 1, K = 1, Q_{n+1} = \overline{Q_n}$.

R	S	Q	\bar{Q}
1	0	0	1
0	1	1	0
1	1	previous	
0	0	invalid	

Truth table for RS latch

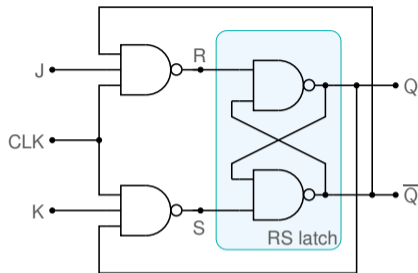

CLK	J	K	Q (Q_{n+1})
0	X	X	previous (Q_n)
1	0	0	previous (Q_n)
1	0	1	0
1	1	0	1
1	1	1	toggles (\bar{Q}_n)

Truth table for JK flip-flop

* When CLK = 1:

- Consider $J = 1, K = 0 \rightarrow S = 1, R = \overline{\overline{Q_n}} = Q_n$.
 - Case (i): $Q_n = 0 \rightarrow R = 0$ (i.e., $R = 0, S = 1$) $\rightarrow Q_{n+1} = 1$.
 - Case (ii): $Q_n = 1 \rightarrow R = 1$ (i.e., $R = 1, S = 1$) $\rightarrow Q_{n+1} = Q_n = 1$.
 - \rightarrow For $J = 1, K = 0, Q_{n+1} = 1$.
- Consider $J = 1, K = 1 \rightarrow R = Q_n, S = \overline{Q_n}$.
 - Case (i): $Q_n = 0 \rightarrow R = 0, S = 1 \rightarrow Q_{n+1} = 1$.
 - Case (ii): $Q_n = 1 \rightarrow R = 1, S = 0 \rightarrow Q_{n+1} = 0$.
 - \rightarrow For $J = 1, K = 1, Q_{n+1} = \overline{Q_n}$.

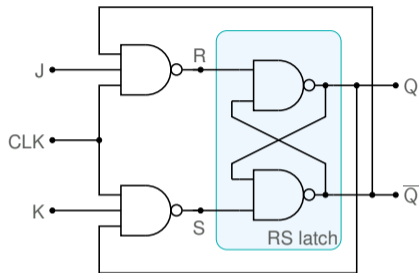

CLK	J	K	$Q(Q_{n+1})$
0	X	X	previous (Q_n)
1	0	0	previous (Q_n)
1	0	1	0
1	1	0	1
1	1	1	toggles (\bar{Q}_n)

Truth table for JK flip-flop

Consider $J = K = 1$ and $CLK = 1$.

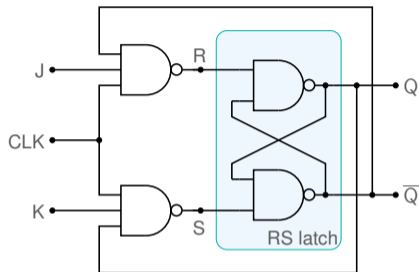

CLK	J	K	Q (Q_{n+1})
0	X	X	previous (Q_n)
1	0	0	previous (Q_n)
1	0	1	0
1	1	0	1
1	1	1	toggles (\bar{Q}_n)

Truth table for JK flip-flop

Consider $J = K = 1$ and $CLK = 1$.

As long as $CLK = 1$, Q will keep toggling! (The frequency will depend on the delay values of the various gates).

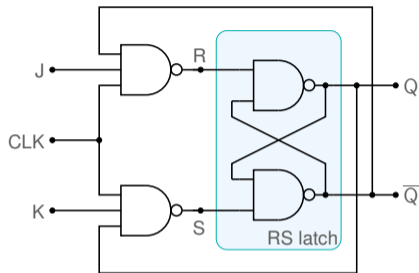

CLK	J	K	$Q(Q_{n+1})$
0	X	X	previous (Q_n)
1	0	0	previous (Q_n)
1	0	1	0
1	1	0	1
1	1	1	toggles (\bar{Q}_n)

Truth table for JK flip-flop

Consider $J = K = 1$ and $CLK = 1$.

As long as $CLK = 1$, Q will keep toggling! (The frequency will depend on the delay values of the various gates).

→ Use the “Master-slave” configuration.

JK flip-flop (Master-Slave)

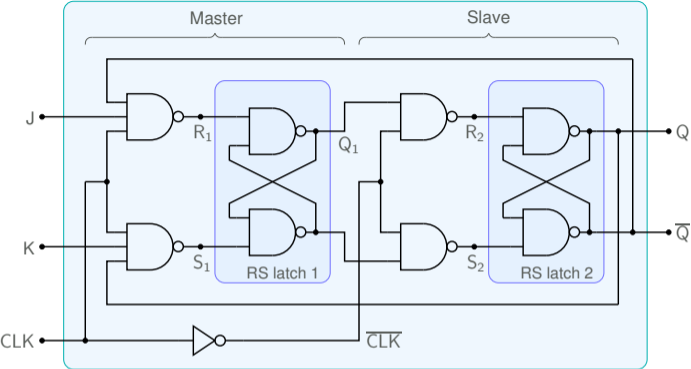

JK flip-flop (Master-Slave)

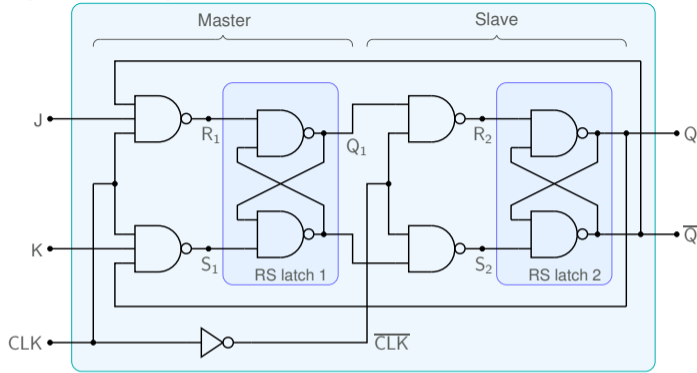

* When CLK goes high, only the first latch is affected; the second latch retains its previous value (because $\overline{\text{CLK}} = 0 \rightarrow R_2 = S_2 = 1$).

JK flip-flop (Master-Slave)

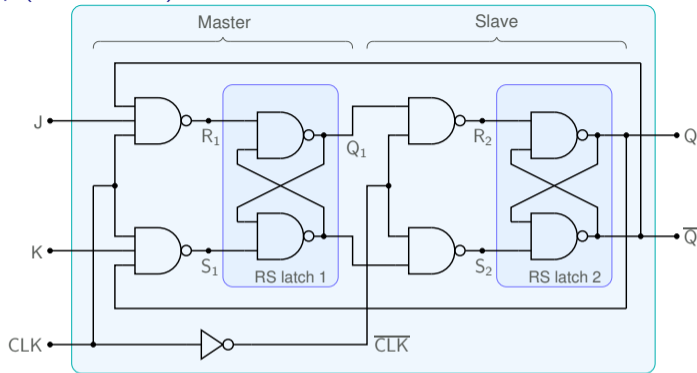

- * When CLK goes high, only the first latch is affected; the second latch retains its previous value (because $\overline{CLK} = 0 \rightarrow R_2 = S_2 = 1$).
- * When CLK goes low, the output of the first latch (Q_1) is retained (since $R_1 = S_1 = 1$), and Q_1 can now affect Q .

JK flip-flop (Master-Slave)

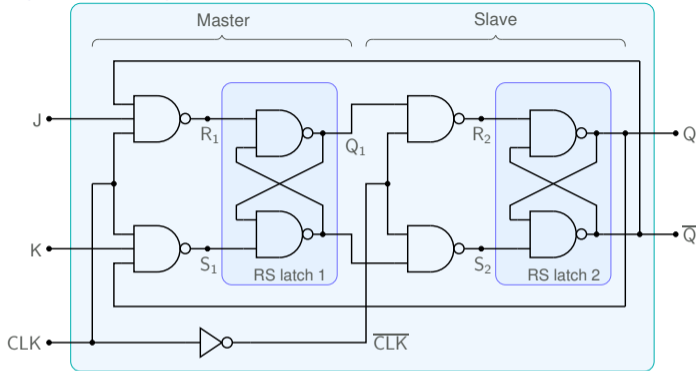

- * When CLK goes high, only the first latch is affected; the second latch retains its previous value (because $\overline{\text{CLK}} = 0 \rightarrow R_2 = S_2 = 1$).
- * When CLK goes low, the output of the first latch (Q_1) is retained (since $R_1 = S_1 = 1$), and Q_1 can now affect Q .
- * In other words, the effect of any changes in J and K appears at the output Q only when CLK makes a transition from 1 to 0.
This is therefore a negative edge-triggered flip-flop.

JK flip-flop (Master-Slave)

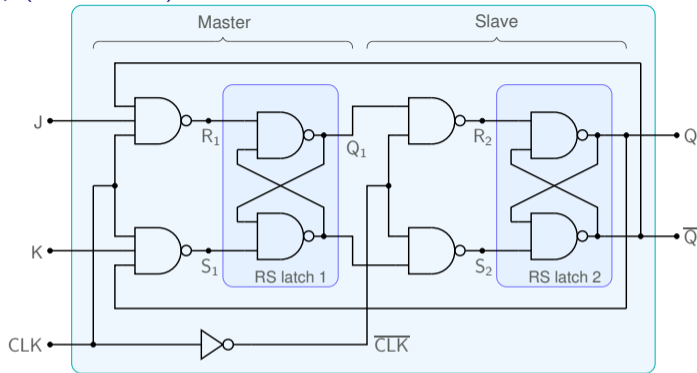

CLK	J	K	Q_{n+1}
↓	0	0	Q_n
↓	0	1	0
↓	1	0	1
↓	1	1	$\overline{Q_n}$

- * When CLK goes high, only the first latch is affected; the second latch retains its previous value (because $\overline{\text{CLK}} = 0 \rightarrow R_2 = S_2 = 1$).
- * When CLK goes low, the output of the first latch (Q_1) is retained (since $R_1 = S_1 = 1$), and Q_1 can now affect Q .
- * In other words, the effect of any changes in J and K appears at the output Q only when CLK makes a transition from 1 to 0.
This is therefore a negative edge-triggered flip-flop.

JK flip-flop (Master-Slave)

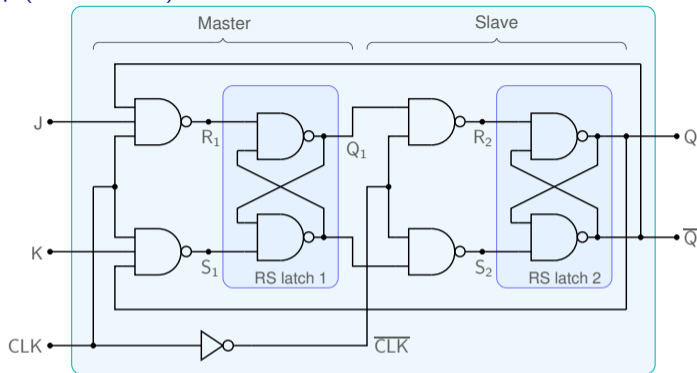

CLK	J	K	Q_{n+1}
↓	0	0	Q_n
↓	0	1	0
↓	1	0	1
↓	1	1	$\overline{Q_n}$

- * When CLK goes high, only the first latch is affected; the second latch retains its previous value (because $\overline{\text{CLK}} = 0 \rightarrow R_2 = S_2 = 1$).
- * When CLK goes low, the output of the first latch (Q_1) is retained (since $R_1 = S_1 = 1$), and Q_1 can now affect Q .
- * In other words, the effect of any changes in J and K appears at the output Q only when CLK makes a transition from 1 to 0.
This is therefore a negative edge-triggered flip-flop.
- * Note that the JK flip-flop allows all four input combinations.

JK flip-flop (Master-Slave)

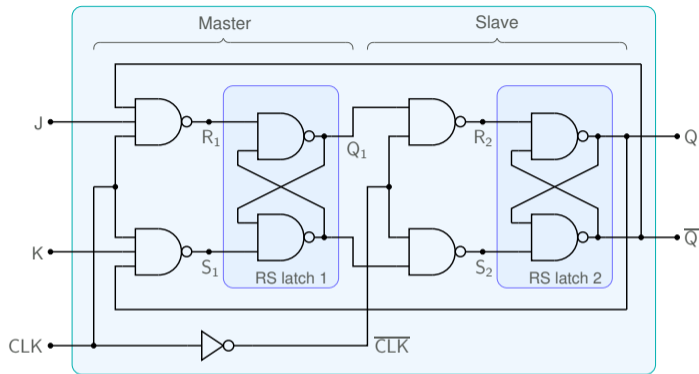

CLK	J	K	Q_{n+1}
↓	0	0	Q_n
↓	0	1	0
↓	1	0	1
↓	1	1	$\overline{Q_n}$

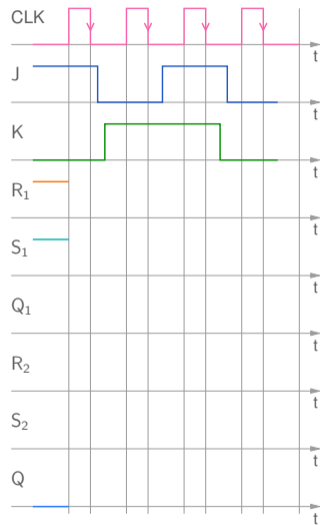

JK flip-flop (Master-Slave)

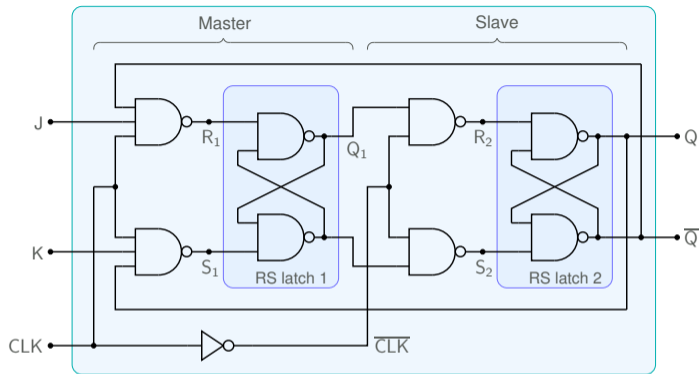

CLK	J	K	Q_{n+1}
↓	0	0	Q_n
↓	0	1	0
↓	1	0	1
↓	1	1	\bar{Q}_n

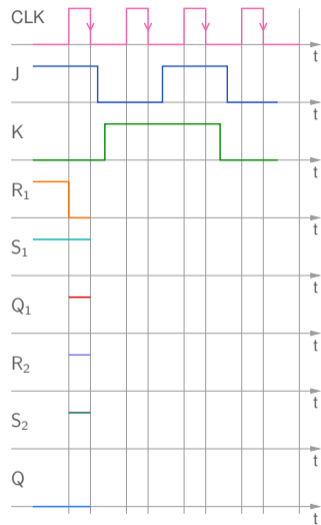

JK flip-flop (Master-Slave)

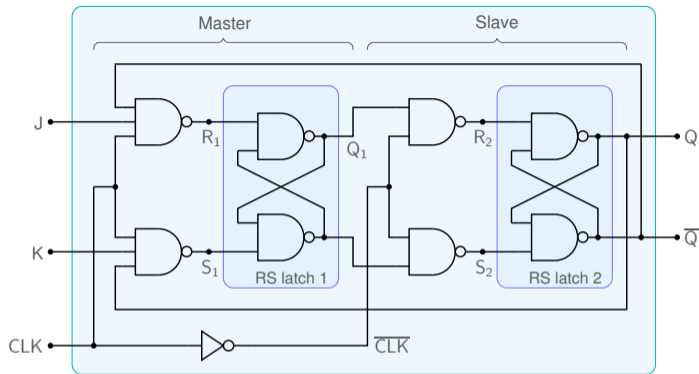

CLK	J	K	Q_{n+1}
↓	0	0	Q_n
↓	0	1	0
↓	1	0	1
↓	1	1	\bar{Q}_n

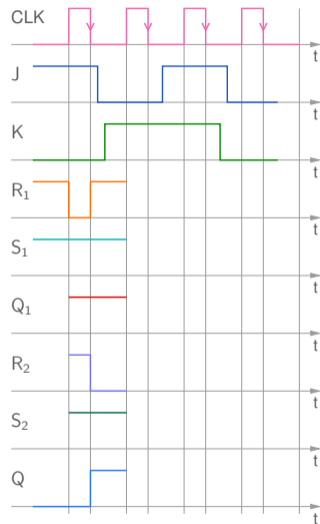

JK flip-flop (Master-Slave)

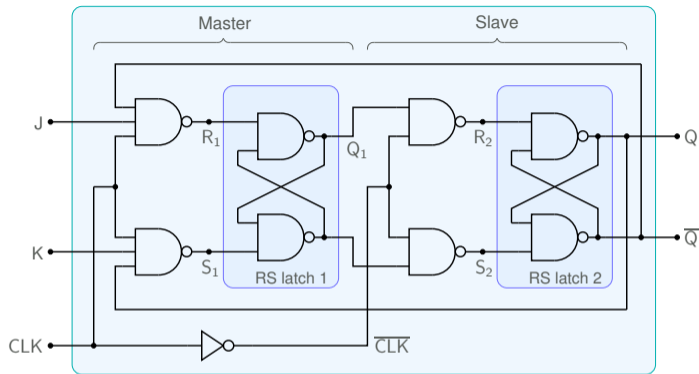

CLK	J	K	Q_{n+1}
↓	0	0	Q_n
↓	0	1	0
↓	1	0	1
↓	1	1	$\overline{Q_n}$

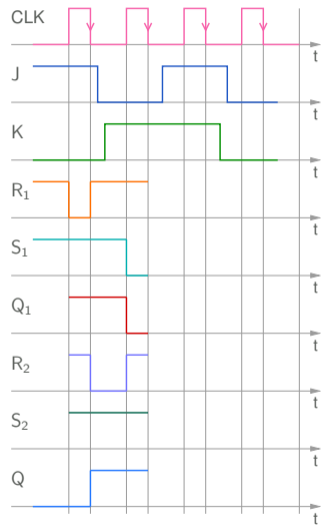

JK flip-flop (Master-Slave)

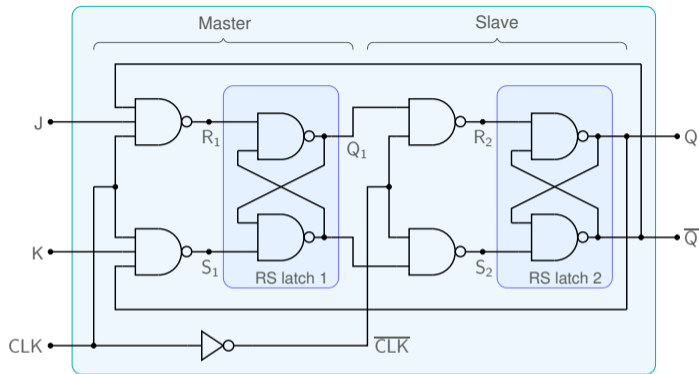

CLK	J	K	Q_{n+1}
↓	0	0	Q_n
↓	0	1	0
↓	1	0	1
↓	1	1	$\overline{Q_n}$

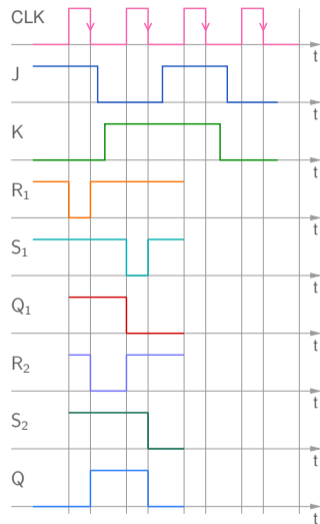

JK flip-flop (Master-Slave)

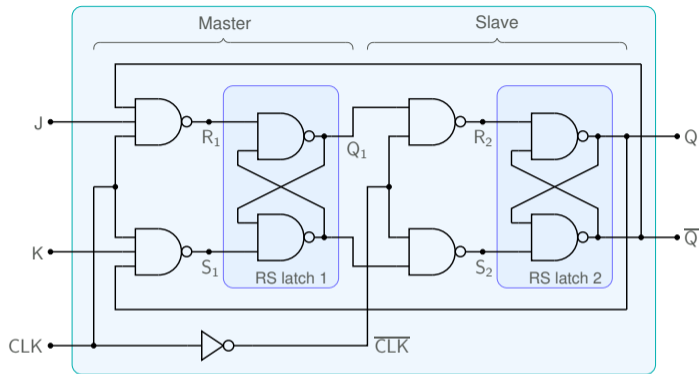

CLK	J	K	Q_{n+1}
↓	0	0	Q_n
↓	0	1	0
↓	1	0	1
↓	1	1	$\overline{Q_n}$

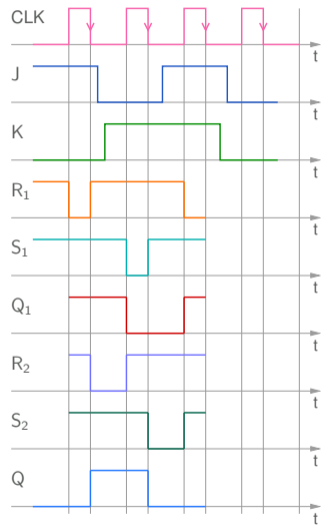

JK flip-flop (Master-Slave)

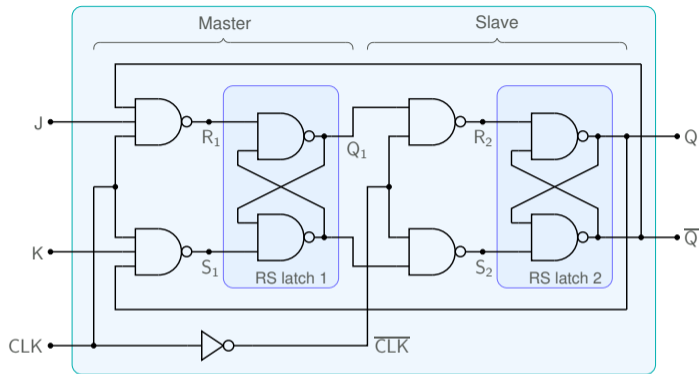

CLK	J	K	Q_{n+1}
↓	0	0	Q_n
↓	0	1	0
↓	1	0	1
↓	1	1	$\overline{Q_n}$

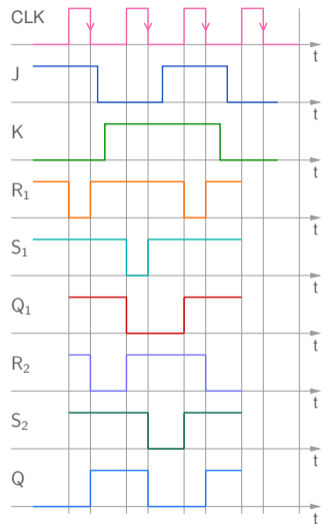

JK flip-flop (Master-Slave)

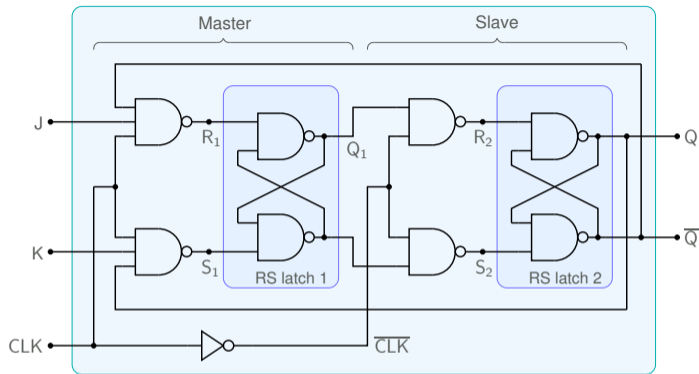

CLK	J	K	Q_{n+1}
↓	0	0	Q_n
↓	0	1	0
↓	1	0	1
↓	1	1	\bar{Q}_n

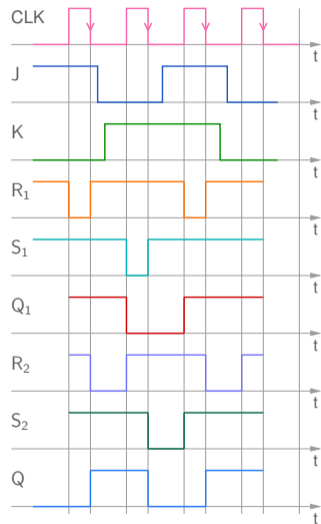

JK flip-flop (Master-Slave)

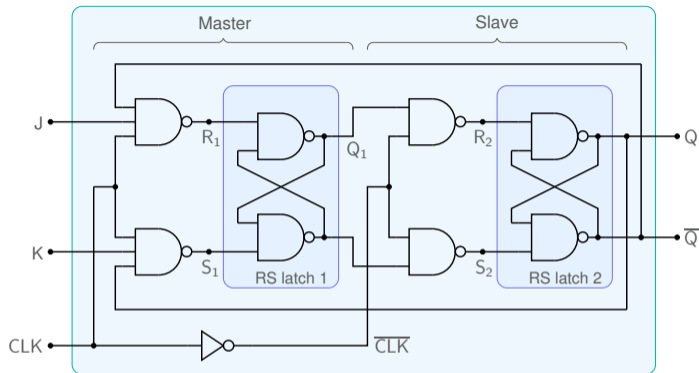

CLK	J	K	Q_{n+1}
↓	0	0	Q_n
↓	0	1	0
↓	1	0	1
↓	1	1	$\overline{Q_n}$

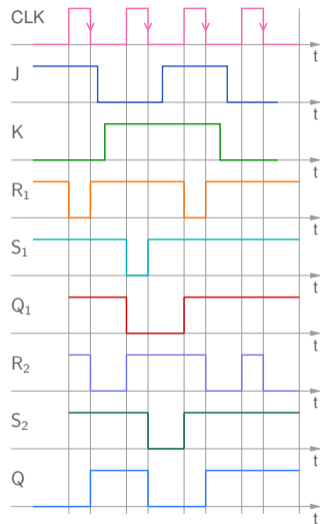

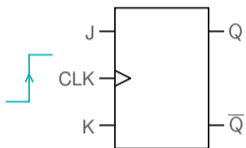

CLK	J	K	Q_{n+1}
↑	0	0	Q_n
↑	0	1	0
↑	1	0	1
↑	1	1	$\overline{Q_n}$

positive edge-triggered JK flip-flop

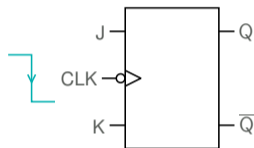

CLK	J	K	Q_{n+1}
↓	0	0	Q_n
↓	0	1	0
↓	1	0	1
↓	1	1	$\overline{Q_n}$

negative edge-triggered JK flip-flop

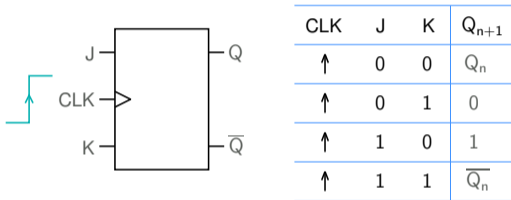

positive edge-triggered JK flip-flop

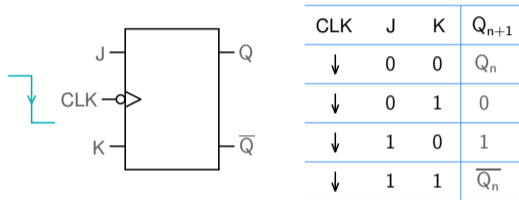

negative edge-triggered JK flip-flop

- * Both negative (e.g., 74ALS112A, CD54ACT112) and positive (e.g., 74ALS109A, CD4027) edge-triggered JK flip-flops are available as ICs.

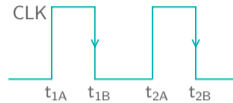
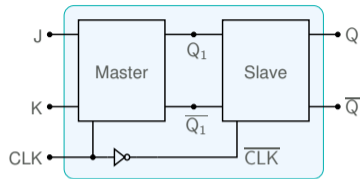

Consider a negative edge-triggered JK flip-flop.

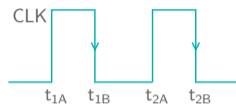
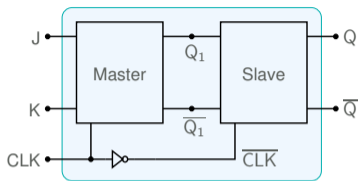

Consider a negative edge-triggered JK flip-flop.

- * As seen earlier, when CLK is high (i.e., $t_{1A} < t < t_{1B}$, etc.), the input J and K determine the Master latch output Q_1 .
During this time, *no change* is visible at the flip-flop output Q .

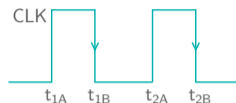
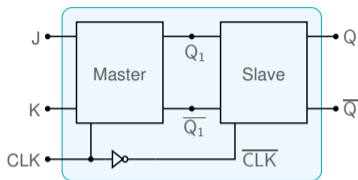

Consider a negative edge-triggered JK flip-flop.

- * As seen earlier, when CLK is high (i.e., $t_{1A} < t < t_{1B}$, etc.), the input J and K determine the Master latch output Q_1 .
During this time, *no change* is visible at the flip-flop output Q .
- * When the clock goes low, the Slave flip-flop becomes active, making it possible for Q to change.

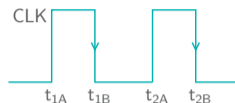
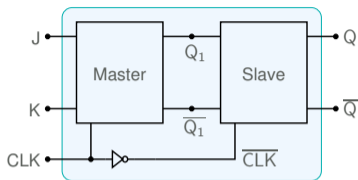

Consider a negative edge-triggered JK flip-flop.

- * As seen earlier, when CLK is high (i.e., $t_{1A} < t < t_{1B}$, etc.), the input J and K determine the Master latch output Q_1 .
During this time, *no change* is visible at the flip-flop output Q .
- * When the clock goes low, the Slave flip-flop becomes active, making it possible for Q to change.
- * In short, although the flip-flop output Q can only change *after* the active edge, (t_{1B} , t_{2B} , etc.), the new Q value is determined by J and K values just *before* the active edge.

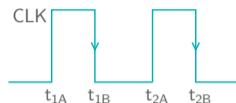
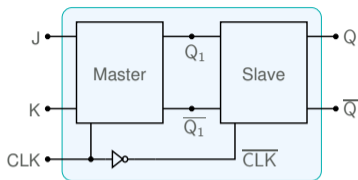

Consider a negative edge-triggered JK flip-flop.

- * As seen earlier, when CLK is high (i.e., $t_{1A} < t < t_{1B}$, etc.), the input J and K determine the Master latch output Q_1 .
During this time, *no change* is visible at the flip-flop output Q .
- * When the clock goes low, the Slave flip-flop becomes active, making it possible for Q to change.
- * In short, although the flip-flop output Q can only change *after* the active edge, (t_{1B} , t_{2B} , etc.), the new Q value is determined by J and K values just *before* the active edge.

This is a very important point!

JK flip-flop

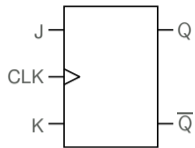

CLK	J	K	Q_{n+1}
↑	0	0	Q_n
↑	0	1	0
↑	1	0	1
↑	1	1	$\overline{Q_n}$

positive edge-triggered JK flip-flop

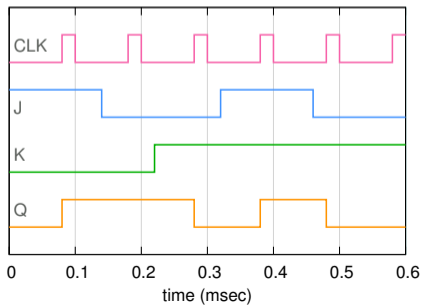

JK flip-flop

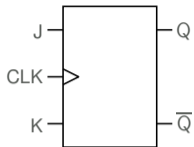

CLK	J	K	Q_{n+1}
↑	0	0	Q_n
↑	0	1	0
↑	1	0	1
↑	1	1	$\overline{Q_n}$

positive edge-triggered JK flip-flop

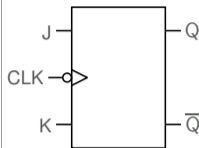
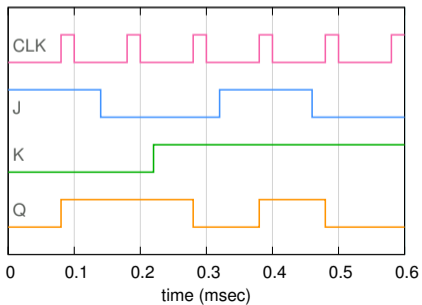

CLK	J	K	Q_{n+1}
↓	0	0	Q_n
↓	0	1	0
↓	1	0	1
↓	1	1	$\overline{Q_n}$

negative edge-triggered JK flip-flop

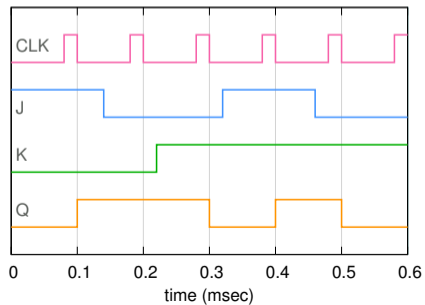

JK flip-flop

$J_1 = K_1 = 1$. Assume $Q_1 = Q_2 = 0$ initially.

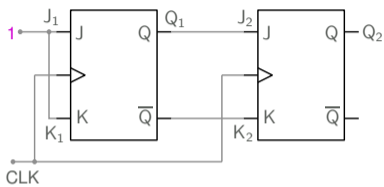

CLK	J	K	Q_{n+1}
↑	0	0	Q_n
↑	0	1	0
↑	1	0	1
↑	1	1	\bar{Q}_n

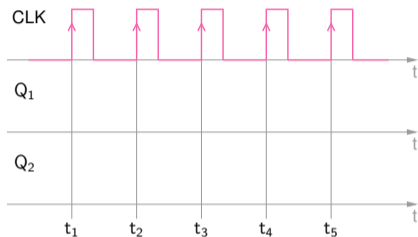

JK flip-flop

$J_1 = K_1 = 1$. Assume $Q_1 = Q_2 = 0$ initially.

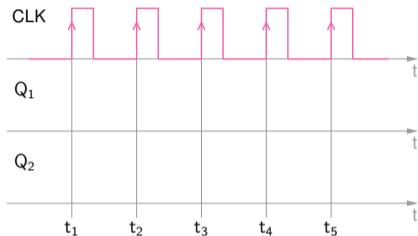
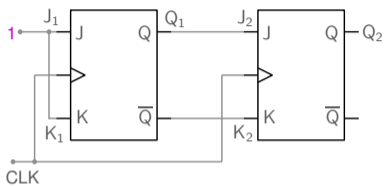

CLK	J	K	Q_{n+1}
↑	0	0	Q_n
↑	0	1	0
↑	1	0	1
↑	1	1	\bar{Q}_n

* Since $J_1 = K_1 = 1$, Q_1 toggles after every active clock edge.

JK flip-flop

$J_1 = K_1 = 1$. Assume $Q_1 = Q_2 = 0$ initially.

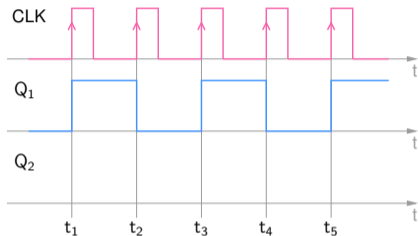
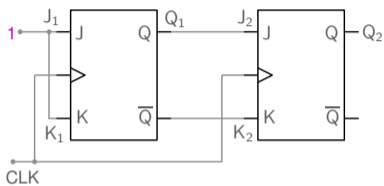

CLK	J	K	Q_{n+1}
↑	0	0	Q_n
↑	0	1	0
↑	1	0	1
↑	1	1	$\overline{Q_n}$

* Since $J_1 = K_1 = 1$, Q_1 toggles after every active clock edge.

JK flip-flop

$J_1 = K_1 = 1$. Assume $Q_1 = Q_2 = 0$ initially.

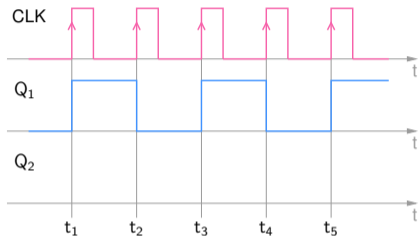
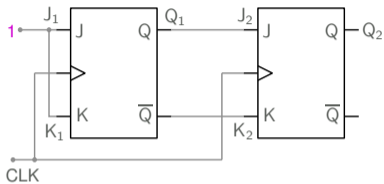

CLK	J	K	Q_{n+1}
↑	0	0	Q_n
↑	0	1	0
↑	1	0	1
↑	1	1	$\overline{Q_n}$

- * Since $J_1 = K_1 = 1$, Q_1 toggles after every active clock edge.
- * $J_2 = Q_1$, $K_2 = \overline{Q_1}$. We need to look at J_2 and K_2 values *just before* the active edge, to determine the next value of Q_2 .

JK flip-flop

$J_1 = K_1 = 1$. Assume $Q_1 = Q_2 = 0$ initially.

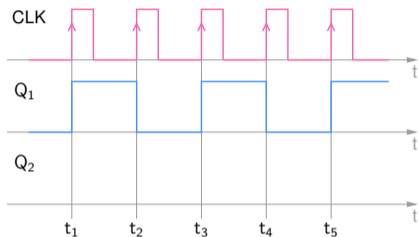
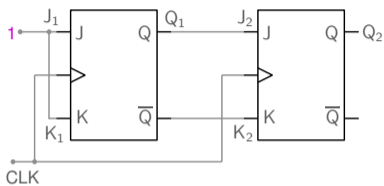

CLK	J	K	Q_{n+1}
↑	0	0	Q_n
↑	0	1	0
↑	1	0	1
↑	1	1	$\overline{Q_n}$

- * Since $J_1 = K_1 = 1$, Q_1 toggles after every active clock edge.
- * $J_2 = Q_1$, $K_2 = \overline{Q_1}$. We need to look at J_2 and K_2 values *just before* the active edge, to determine the next value of Q_2 .
- * It is convenient to construct a table listing J_2 and K_2 to figure out the next Q_2 value.

JK flip-flop

$J_1 = K_1 = 1$. Assume $Q_1 = Q_2 = 0$ initially.

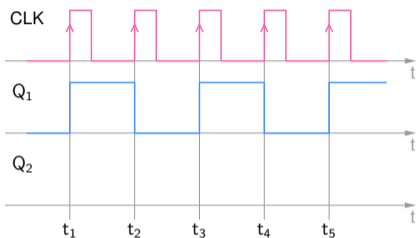
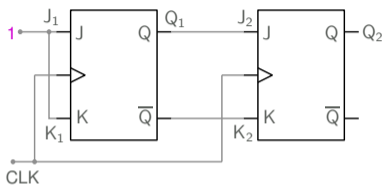

CLK	J	K	Q_{n+1}
↑	0	0	Q_n
↑	0	1	0
↑	1	0	1
↑	1	1	$\overline{Q_n}$

t	$J_2(t = t_k^-)$	$K_2(t = t_k^-)$	$Q_2(t = t_k^+)$
t_1	0	1	0
t_2	1	0	1
t_3	0	1	0
t_4	1	0	1
t_5	0	1	0

- * Since $J_1 = K_1 = 1$, Q_1 toggles after every active clock edge.
- * $J_2 = Q_1$, $K_2 = \overline{Q_1}$. We need to look at J_2 and K_2 values *just before* the active edge, to determine the next value of Q_2 .
- * It is convenient to construct a table listing J_2 and K_2 to figure out the next Q_2 value.

JK flip-flop

$J_1 = K_1 = 1$. Assume $Q_1 = Q_2 = 0$ initially.

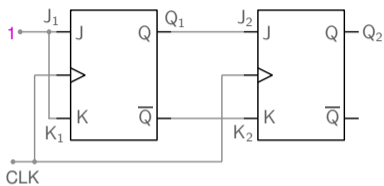

CLK	J	K	Q_{n+1}
↑	0	0	Q_n
↑	0	1	0
↑	1	0	1
↑	1	1	$\overline{Q_n}$

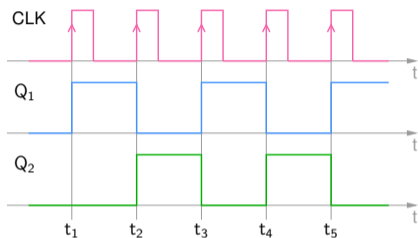

t	$J_2(t = t_k^-)$	$K_2(t = t_k^-)$	$Q_2(t = t_k^+)$
t_1	0	1	0
t_2	1	0	1
t_3	0	1	0
t_4	1	0	1
t_5	0	1	0

- * Since $J_1 = K_1 = 1$, Q_1 toggles after every active clock edge.
- * $J_2 = Q_1$, $K_2 = \overline{Q_1}$. We need to look at J_2 and K_2 values *just before* the active edge, to determine the next value of Q_2 .
- * It is convenient to construct a table listing J_2 and K_2 to figure out the next Q_2 value.

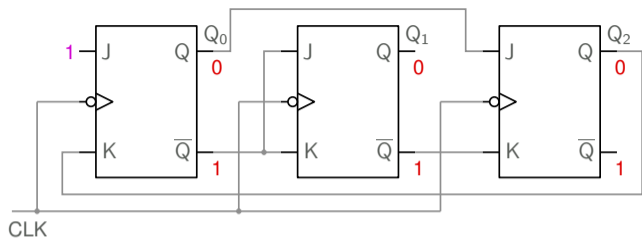

CLK	J	K	Q_{n+1}
↓	0	0	Q_n
↓	0	1	0
↓	1	0	1
↓	1	1	$\overline{Q_n}$

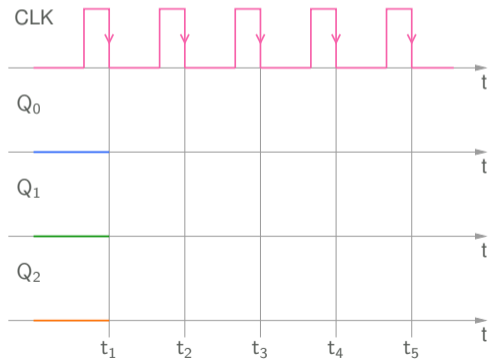

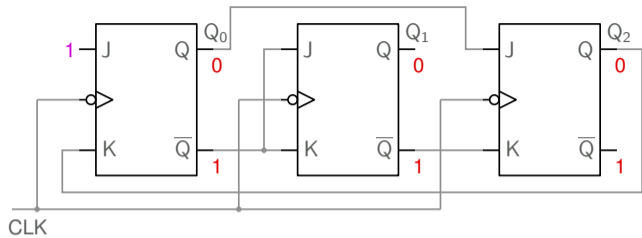

CLK	J	K	Q_{n+1}
↓	0	0	Q_n
↓	0	1	0
↓	1	0	1
↓	1	1	$\overline{Q_n}$

t	t_k^-								t_k^+			
	Q_0	Q_1	Q_2	J_0	K_0	J_1	K_1	J_2	K_2	Q_0	Q_1	Q_2
t_1	0	0	0	1	0	1	1	0	1			
t_2												
t_3												
t_4												
t_5												

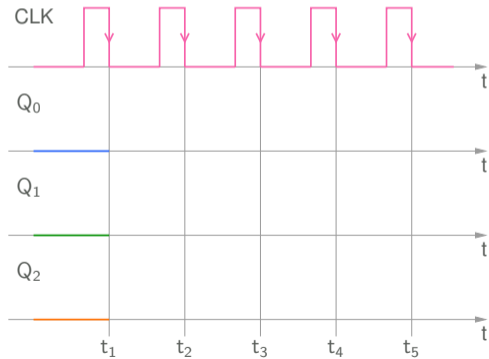

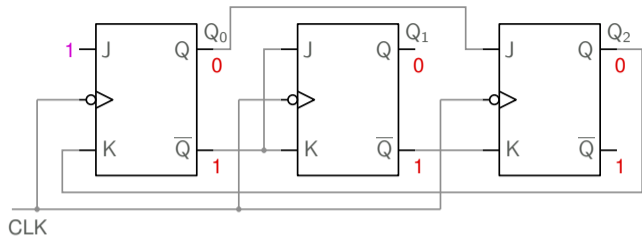

CLK	J	K	Q_{n+1}
↓	0	0	Q_n
↓	0	1	0
↓	1	0	1
↓	1	1	$\overline{Q_n}$

t	t_k^-								t_k^+			
	Q_0	Q_1	Q_2	J_0	K_0	J_1	K_1	J_2	K_2	Q_0	Q_1	Q_2
t_1	0	0	0	1	0	1	1	0	1	1	0	
t_2												
t_3												
t_4												
t_5												

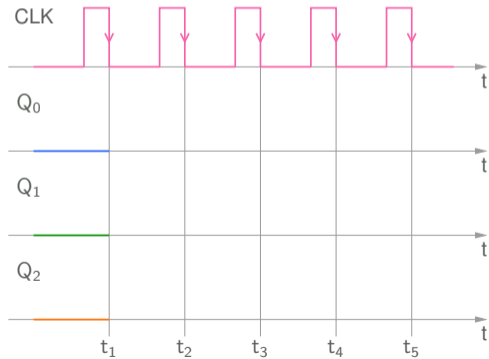

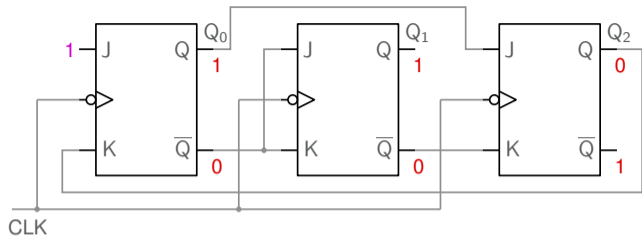

CLK	J	K	Q_{n+1}
↓	0	0	Q_n
↓	0	1	0
↓	1	0	1
↓	1	1	$\overline{Q_n}$

t	t_k^-								t_k^+			
	Q_0	Q_1	Q_2	J_0	K_0	J_1	K_1	J_2	K_2	Q_0	Q_1	Q_2
t_1	0	0	0	1	0	1	1	0	1	1	0	
t_2	1	1	0	1	0	0	0	1	0			
t_3												
t_4												
t_5												

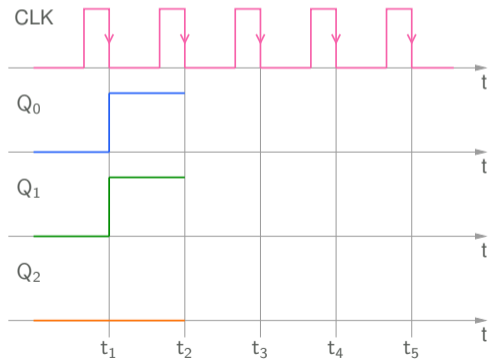

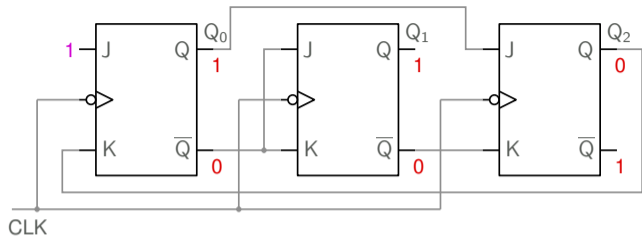

CLK	J	K	Q_{n+1}
↓	0	0	Q_n
↓	0	1	0
↓	1	0	1
↓	1	1	$\overline{Q_n}$

t	t_k^-								t_k^+		
	Q_0	Q_1	Q_2	J_0	K_0	J_1	K_1	J_2	K_2	Q_0	Q_1
t_1	0	0	0	1	0	1	1	0	1	1	0
t_2	1	1	0	1	0	0	0	1	0	1	1
t_3											
t_4											
t_5											

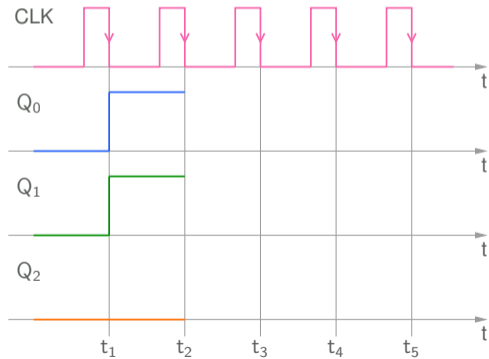

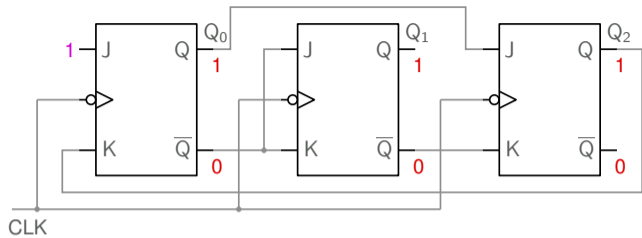

CLK	J	K	Q_{n+1}
↓	0	0	Q_n
↓	0	1	0
↓	1	0	1
↓	1	1	$\overline{Q_n}$

t	t_k^-								t_k^+		
	Q_0	Q_1	Q_2	J_0	K_0	J_1	K_1	J_2	K_2	Q_0	Q_1
t_1	0	0	0	1	0	1	1	0	1	1	0
t_2	1	1	0	1	0	0	0	1	0	1	1
t_3	1	1	1	1	1	0	0	1	0		
t_4											
t_5											

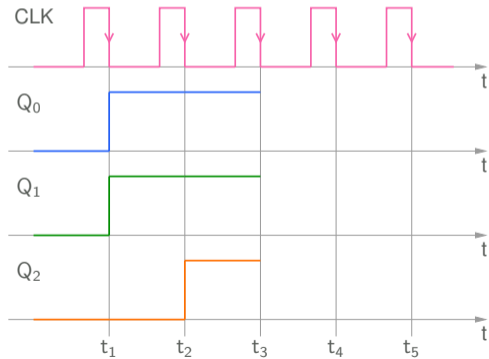

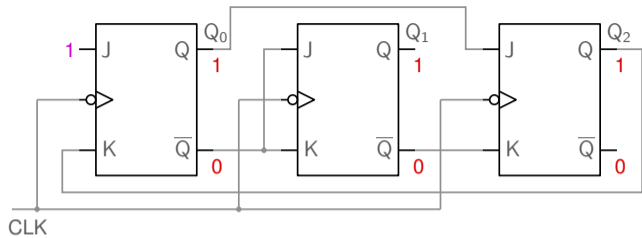

CLK	J	K	Q_{n+1}
↓	0	0	Q_n
↓	0	1	0
↓	1	0	1
↓	1	1	$\overline{Q_n}$

t	t_k^-								t_k^+		
	Q_0	Q_1	Q_2	J_0	K_0	J_1	K_1	J_2	K_2	Q_0	Q_1
t_1	0	0	0	1	0	1	1	0	1	1	0
t_2	1	1	0	1	0	0	0	1	0	1	1
t_3	1	1	1	1	1	0	0	1	0	0	1
t_4											
t_5											

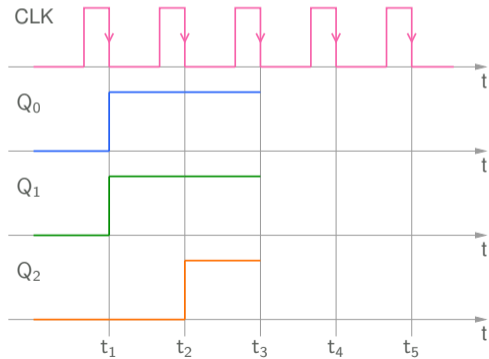

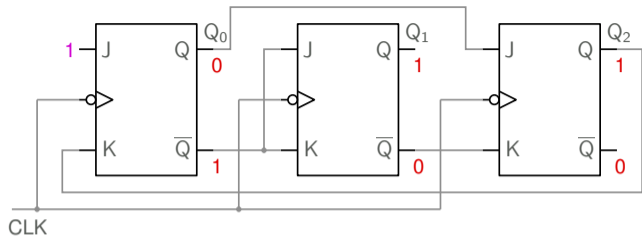

CLK	J	K	Q_{n+1}
↓	0	0	Q_n
↓	0	1	0
↓	1	0	1
↓	1	1	$\overline{Q_n}$

t	t_k^-								t_k^+		
	Q_0	Q_1	Q_2	J_0	K_0	J_1	K_1	J_2	K_2	Q_0	Q_1
t_1	0	0	0	1	0	1	1	0	1	1	0
t_2	1	1	0	1	0	0	0	1	0	1	1
t_3	1	1	1	1	1	0	0	1	0	0	1
t_4	0	1	1	1	1	1	1	0	0		
t_5											

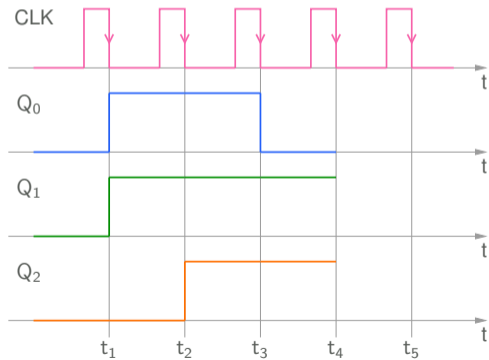

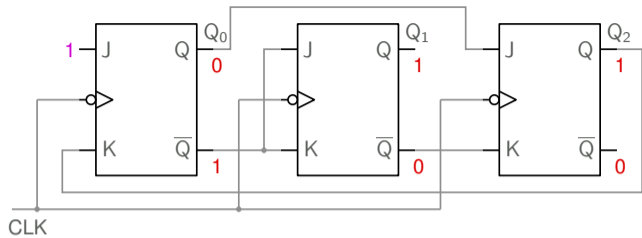

CLK	J	K	Q_{n+1}
↓	0	0	Q_n
↓	0	1	0
↓	1	0	1
↓	1	1	$\overline{Q_n}$

t	t_k^-								t_k^+		
	Q_0	Q_1	Q_2	J_0	K_0	J_1	K_1	J_2	K_2	Q_0	Q_1
t_1	0	0	0	1	0	1	1	0	1	1	0
t_2	1	1	0	1	0	0	0	1	0	1	1
t_3	1	1	1	1	1	0	0	1	0	0	1
t_4	0	1	1	1	1	1	1	0	0	1	0
t_5											

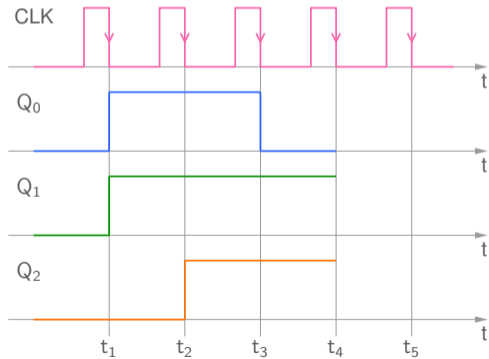

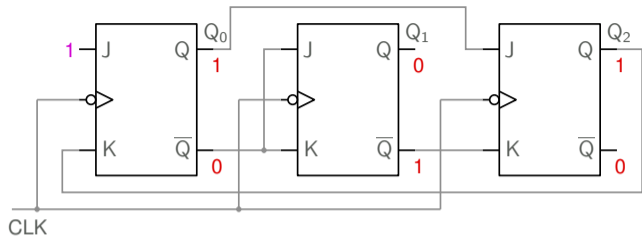

CLK	J	K	Q_{n+1}
↓	0	0	Q_n
↓	0	1	0
↓	1	0	1
↓	1	1	$\overline{Q_n}$

t	t_k^-								t_k^+		
	Q_0	Q_1	Q_2	J_0	K_0	J_1	K_1	J_2	K_2	Q_0	Q_1
t_1	0	0	0	1	0	1	1	0	1	1	0
t_2	1	1	0	1	0	0	0	1	0	1	1
t_3	1	1	1	1	1	0	0	1	0	0	1
t_4	0	1	1	1	1	1	1	0	0	1	0
t_5	1	0	1	1	1	0	0	1	1		

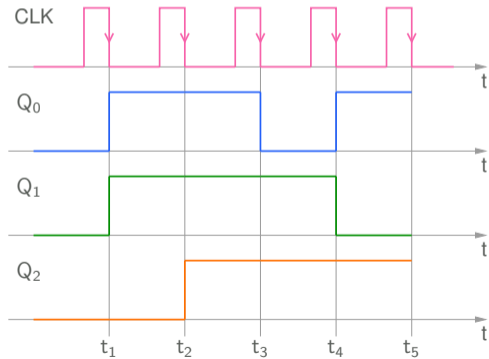

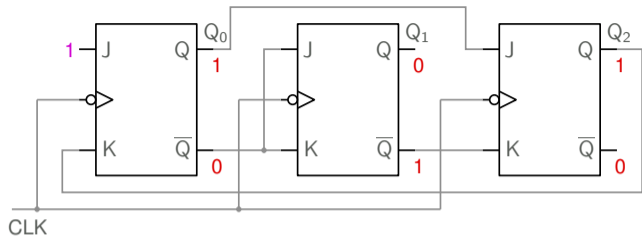

CLK	J	K	Q_{n+1}
↓	0	0	Q_n
↓	0	1	0
↓	1	0	1
↓	1	1	$\overline{Q_n}$

t	t_k^-								t_k^+		
	Q_0	Q_1	Q_2	J_0	K_0	J_1	K_1	J_2	K_2	Q_0	Q_1
t_1	0	0	0	1	0	1	1	0	1	1	0
t_2	1	1	0	1	0	0	0	1	0	1	1
t_3	1	1	1	1	1	0	0	1	0	0	1
t_4	0	1	1	1	1	1	1	0	0	1	0
t_5	1	0	1	1	1	0	0	1	1	0	0

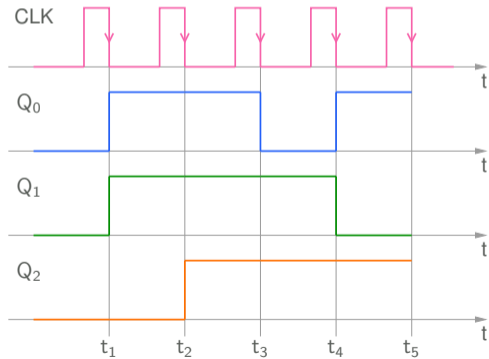

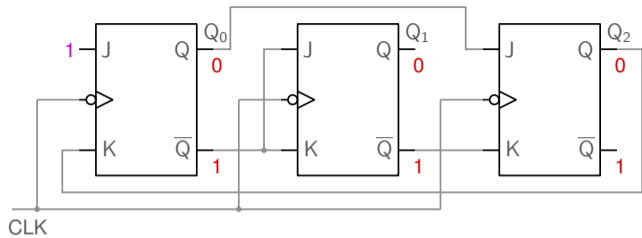

CLK	J	K	Q_{n+1}
↓	0	0	Q_n
↓	0	1	0
↓	1	0	1
↓	1	1	$\overline{Q_n}$

t	t_k^-								t_k^+		
	Q_0	Q_1	Q_2	J_0	K_0	J_1	K_1	J_2	K_2	Q_0	Q_1
t_1	0	0	0	1	0	1	1	0	1	1	0
t_2	1	1	0	1	0	0	0	1	0	1	1
t_3	1	1	1	1	1	0	0	1	0	0	1
t_4	0	1	1	1	1	1	1	0	0	1	0
t_5	1	0	1	1	1	0	0	1	1	0	0

